

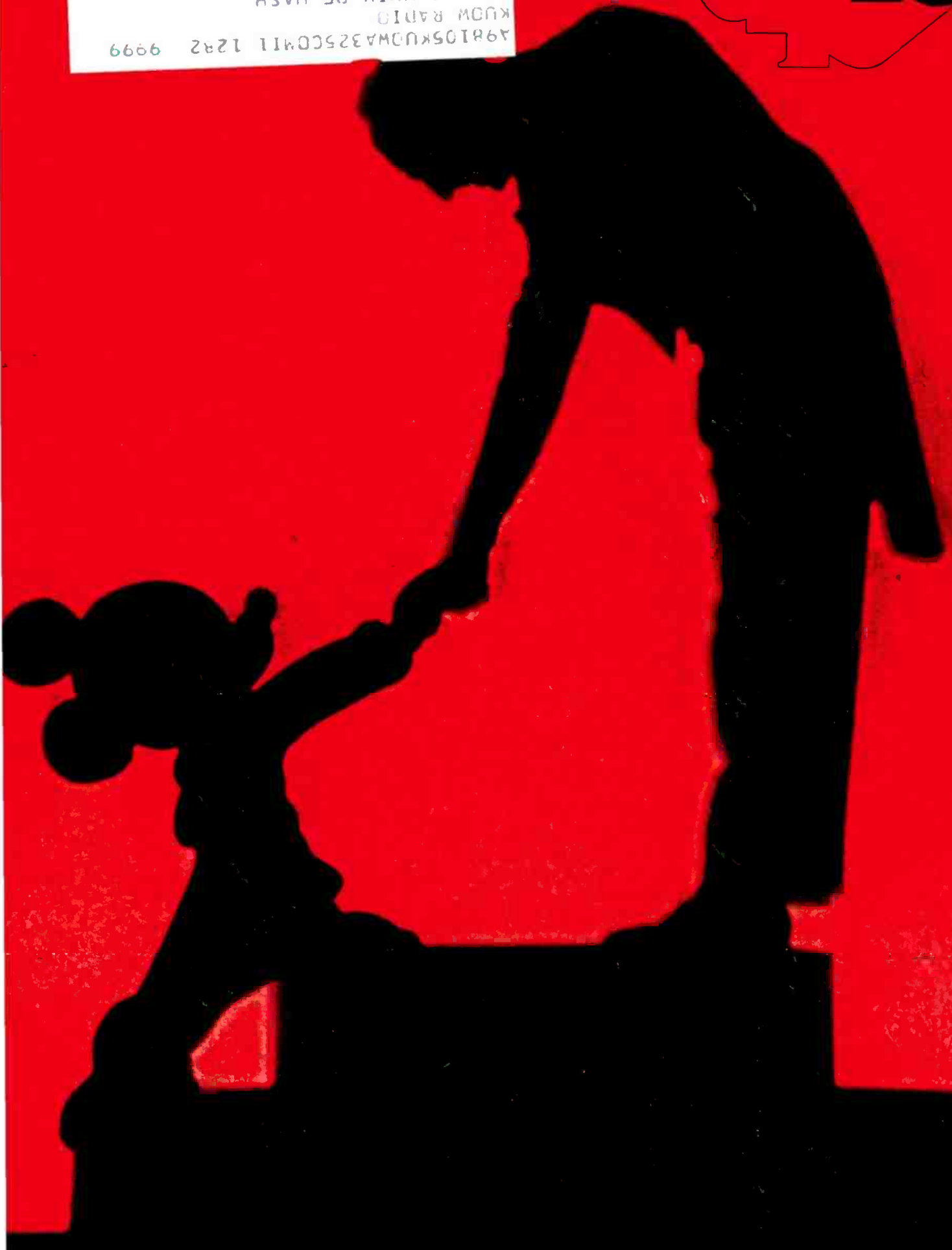

SEATTLE
325 COMMUNICATIONS BLDG
D S 50 UNIV OF WASH
KUON RADIO
298105KUON4325COMM11 1282 9999



WHY MITSUBISHI

© 1982 Mitsubishi Electric Sales of America, Inc.

No noise and perfect reproduction are expected from a digital recorder. But the performance of the Mitsubishi X-80 digital recorder at Fantasy Studios is why you should investigate owning this one.

As you've already heard, digital is big news. In fact, Roy Segal compares digital with the introduction of magnetic tape, and the advent of the transistor. And that's pretty good company.

Roy puts it this way. "Digital will supplant analog, period. It's simply a question of when. Recently, I AB'd the Mitsubishi X-80 in my own studio and for me the time is now."

No wonder. With a 35 db increase in S/N ratio, the total absence of hiss and added noise, and an uncanny ability to reproduce the dynamics of original performance, the Mitsubishi X-80 comes about as close to perfection as our greatest minds can take us.

But there's more to this machine than meets the ears, and that's why we went to a man who has been in the audio engineering business for 34 years.



"In a little over a year, we've made 24 albums direct from digital. And like anything else, a proven track record is the best reason to buy!"

Roy Segal
Executive Vice President
Fantasy Studios

Roy Segal did not accept any compensation for this endorsement.

"We chose the X-80 because it's a natural extension of the analog recording system." It uses 1/4 inch tape. It has a traditional open reel format. And it's the only digital machine that's designed for good old razor blade mechanical editing.

But what Roy likes best about the X-80 is this: "When you consider the quality, the reliability and the price of this machine, it's totally cost effective."

When Fantasy Studios produces a digital master on the X-80, the record companies can make disc lacquers directly from it, and make as many first generation analog masters as they require. The end product sounds better. It sells better. And the artists come back to Fantasy Studios.

Call or write us for more information. Because as Roy Segal told us, "...the Mitsubishi X-80 not only sounds good, it's good for business."



MITSUBISHI
DIGITAL AUDIO SYSTEMS

800-631-5377 (Outside New Jersey)
201-981-1414 (Within New Jersey)

THE PORTABLE X-80
2-Channel Digital Audio Recorder.



Circle 11 on Reader Service Card

Publisher
Larry Zide
Editor
John M. Woram
European Editor
John Borwick
Associate Editor
Mark B. Waldstein
Production & Layout
David Kramer
Advertising Coordinator
Karen Cohn
Classified Advertising
Carol Vitelli
Book Sales
Lydia Calogrides
Circulation Manager
Eloise Beach
Art Director
Bob Laurie
Graphics
K & S Graphics
Typography
Spartan Phototype Co.

sales offices
Roy McDonald Associates, Inc.
Dallas, Texas 75207
First Continental Bank Bldg.
801 Marvin D. Love Freeway
Suite 303
(214) 941-4461
Denver, Colorado Area
Englewood, Colorado 80112
14 Inverness Dr. East
Bldg. 1—Penthouse
(303) 771-8181
Houston, Texas 77036
6901 Corporate Drive
Suite 210
(713) 988-5005
Los Angeles Area
Glendale, California 91204
424 West Colorado Street
Suite 201
(213) 244-8176
Portland Area
Hillsboro, Oregon 97123
510 South First
P.O. Box 696
(503) 640-2011
San Francisco Area
Emeryville, California 94608
265 Baybridge Office Plaza
5801 Christie Avenue
(415) 653-2122
Sagamore Publishing Co.
New York
Plainview, NY 11803
1120 Old Country Rd.
(516) 433-6530

About The Cover

• Legendary conductor Leopold Stokowski is congratulated by Mickey Mouse, "The Sorcerer's Apprentice," in this scene from Walt Disney's animated classic, *Fantasia*. In color by Technicolor and featuring a new digitally rerecorded Dolby® stereophonic soundtrack, *Fantasia* is re-released by Buena Vista. Irwin Kostal conducted, based on the original soundtrack by Stokowski. © MAMMI Walt Disney Productions.



DECEMBER 1982 VOLUME 16, NO. 12

FEATURES

TIME CODE AND MR. EDISON 30	Art Shifrin
THE WONDERFUL SOUND WORLD OF WALT DISNEY 38	Ralph Hodges
SOUND ENGINEERING FOR THEATRE AND FILM 42	John Borwick
COUNTDOWN TO THE 21st CENTURY 48	Bruce Mallion
INDEX OF ARTICLES 62	

DEPARTMENTS

LETTERS	EDITORIAL	CLASSIFIED
6	28	56
SOUND REINFORCEMENT 8		John Eargle
THEORY AND PRACTICE 14		Ken Pohlmann
DIGITAL AUDIO 20		Barry Blesser
SOUND WITH IMAGES 25		Len Feldman
NEW PRODUCTS AND SERVICES 53		
PEOPLE, PLACES, HAPPENINGS 58		

db, the Sound Engineering Magazine (ISSN 0011-7145) is published monthly by Sagamore Publishing Company, Inc. Entire contents copyright © 1982 by Sagamore Publishing Co., 1120 Old Country Road, Plainview, L.I., N.Y. 11803. Telephone (516) 433-6530. db is published for those individuals and firms in professional audio-recording, broadcast, audio-visual, sound reinforcement, consultants, video recording, film sound, etc. Application should be made on the subscription form in the rear of each issue. Subscriptions are \$15.00 per year (\$28.00 per year outside U.S. Possessions, \$16.00 per year Canada) in U.S. funds. Single copies are \$1.95 each. Editorial, Publishing and Sales Offices, 1120 Old Country Road, Plainview, New York 11803. Controlled circulation postage paid at Plainview, NY 11803 and an additional mailing office.

MAP 3320 COMPRESSOR LIMITER (5 1/4" x 1 1/2")

COMPLEMENTARY "MAP a good sound future"

MODULAR AUDIO PRODUCTS
 A UNIT OF MODULAR DEVICES, INC.
 50 Orville Drive • Airport International Plaza • Bohemia, New York 11716 • 516-567-9820

Circle 13 on Reader Service Card

Audio Tape
for professionals

REEL TO REEL TAPE
Ampex, 3M. All grades.
On reels or hubs.

CASSETTES, C-10—C-90
With Agfa, TDK tape.

LEADER & SPLICING TAPE

EMPTY REELS & BOXES
All widths, sizes.

Competitive!
Shipped from Stock!

Ask for our recording supplies catalog.

Polyline Corp. 312/298-5300
1233 Rand Rd. • Des Plaines, IL 60016

Circle 14 on Reader Service Card

Letters

RECOGNITION AT LAST

TO THE EDITOR:

May I add a postscript to Len Feldman's "Sound With Images" column in your April issue?

Another unsung hero of the electronics era is the late Rene Schnepwanger, the inventor of the long-playing microgroove record. He developed the record for RCA in the early forties. RCA, hell-bent on TV, did not run with it, so he finalized the product for CBS, who successfully marketed it in the late forties.

To the injury of receiving no recognition for this tremendous contribution to the art, CBS added the insult of fully crediting this great invention to its laboratory director, Rene, my friend and a gentleman, recounted this sorry episode: a colleague of his has confirmed it to me.

F. G. GREENBERG,
Dutchess Tel-Audio, Inc.
Poughkeepsie, New York

db replies:

At the 1960 convention of the Audio Engineering Society, Mr. Schnepwanger received the Society's Emile Berliner Award for Outstanding Development in the Field of Audio Engineering. The award was presented "...in recognition of his contributions to fine-groove recording. While with the Columbia Broadcasting System in 1944, Mr. Snepvangers (sic?) was project leader for the development of the LP record, and worked on most of the fine-groove pickups used by the LP industry."

We haven't been able to uncover any information about earlier work done at RCA, although we understand that work on the LP record was going on there during the 1930s. Unfortunately, RCA's PR department is not very communicative about these things, as we have discovered on several occasions. If any readers have any information about the very earliest days of the LP, at RCA or elsewhere, please let us know.

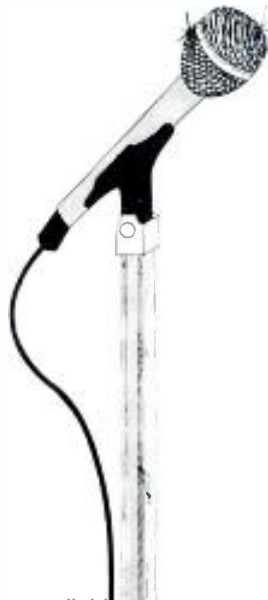

Index of Advertisers

Altec	15
Ampex	47
Audio + Design Rec.	35
Beyer	9
Bose	13
C-TAB	16
Dolby	19
Datatronix	45
Electro-Voice	17
Emilar	8
Garner	14
Goldline	12
Klark-Teknik	Cover IV
Lexicon	Cover III
Linear & Digital Systems, Inc.	12
Microphonics	18
Mitsubishi	Cover II
Modular Audio Products	6
PAIA	8
Polyline	6
Shure	21
Sound Technology	29
STL	43
Studer Revox	11
Swintek	10
Tektronix	23
Telex	39
TOA	7
UREI	27
Vistar	42

Coming Next Month

• In January, db welcomes the new year with its Digital Issue. Warren Simmons checks in with a piece on Analog Mastering Tape vs. Digital Mastering Tape. Ken Pohlmann tackles the problem of how to properly label a digitally rerecorded analog product, and Editor John Woram brings us an excerpt from a new section of his revised *Recording Studio Handbook*. In addition, we'll take another look at some of the hardware featured at the recently concluded AES convention. All this—and much more—coming in the January issue of db—*The Sound Engineering Magazine*.

Toa speaker components give more power to more professionals.



1. HSH-651 Sectoral Horn 2. HRH-851 Radial Horn (large size) 3. HRH-651 Radial Horn (middle size) 4. HRH-311 Radial Horn (small size) 5. HLS-3806 Low-Frequency Speaker 6. HLS-3006 Low-Frequency Speaker 7. HLS-3010 Low-Frequency Speaker 8. HLS-3812 Low-Frequency Speaker 9. HNW-351 Dividing Network (3-way) 10. HNW-251 Dividing Network (2-way) 11. HPF-151-8 High Pass Filter 12. HFD-651 High Frequency Compression Driver 13. HFD-352 High Frequency Compression Driver 14. HT-371 Horn Tweeter

Toa speaker components are the product of years of Toa experience with sound reinforcing equipment and with the dedicated professionals who use them. To ensure that these experts have all the sound quality, efficiency and durability they've come to expect in speaker components, we've designed ours to do more. Toa offers 15 & 12 inch woofers with an edge-wound copper ribbon voice coil and high flux density ferrite magnet; radial and sectoral design horns with 90° horizontal and 40° vertical dispersion; highly efficient compression driver units with smooth reproduction characteristics (power handling of 20W and 60W continuous pink noise); a tweeter with a newly developed exponential oval horn to ensure wide dispersion. And to make sure all these units work together at their best, Toa also provides

an ultra-smoothly operating high-pass filter and crossover network.

The professionals at Toa put more into their speaker components so the pros who use them have the best possible audio.

Toa is also looking for professional-level dealership enquiries and OEM arrangements to help meet growing demand for the full line of high quality Toa sound products. Contact Toa for more information.



TOA ELECTRIC CO., LTD.

ADDRESS: 2-1 TAKAMATSU-CHO, TAKARAZUKA, HYOGO 665, JAPAN
MAILING ADDRESS: P.O. BOX 702, KOBE PORT, JAPAN PHONE: 0797-71-2211
CABLE: TOAELECTRIC TAKARAZUKA TELEX: J64150 TOA PA

• For further information, contact your nearest Toa office:

WEST GERMANY Toa Electric Deutschland G.m.b.H., Kaiser Wilhelm Str. 89, 2000 Hamburg 36, West Germany
PHONE: 040-345742/344213

U.S.A. Toa Electronics, Inc., 480 Carton Court, South San Francisco, Ca. 94080, U.S.A. PHONE: 415-588-2538

Circle 46 on Reader Service Card



EL-15 Woofer

- 25-5000 Hz
- 200 Watts
- 100 dB M/W
- 4" Voice Coil

EMILAR

For complete information:

(714) 632-8500

(800) 854-7181

EMILAR CORPORATION

1365 N. McCan St.,
Anaheim, CA 92806

Circle 15 on Reader Service Card



In general, spring reverbs don't have the best reputation in the world. Their bassy "twang" is only a rough approximation of natural room acoustics. That's a pity because it means that many people will dismiss this exceptional product as "just another spring reverb". And it's not. In this extraordinary design Craig Anderton uses double springs, but much more importantly "hot rod's" the transducers so that the muddy sound typical of most springs is replaced with the bright clarity associated with expensive studio plate systems.

Kit consists of circuit board, instructions, all electronic parts and two reverb spring units. User must provide power (± 9 to 15v) and mounting (reverb units are typically mounted away from the console).

CHARGE TO VISA OR MC TOLL-FREE
1-800-654-8657 9AM to 5PM CST MON-FRI

DIRECT INQUIRIES TO:

PAIA Electronics, Inc.

Dept. II C, 1020 W. Wilshire Bv. Oklahoma City, OK 73116 (405) 843-9626

- Send the 6740 REVERB KIT \$59.95 plus shipping (\$3) enclosed or charged.
- Send Free Catalog

name _____

address _____

city _____ state _____ zip _____

Circle 16 on Reader Service Card

JOHN EARGLE

Sound Reinforcement

Sound Fields, Part 3

INTRODUCTION

• In this final section on sound fields we will examine several methods of augmenting sound fields through electro-acoustical means. The needs for such augmentation may occur when a performance space has to serve many purposes. The space may have a relatively short reverberation time in order to accommodate lectures or motion pictures. Such a space would have a too-short reverberation time for music, and some means of increasing it would extend the usefulness of the space.

Three methods of increasing reverberation time will be discussed: *sound field amplification*, as developed by the Philips company of Holland; *sound field modelling*, using time delay and reverberation generators; and *assisted resonance*, as used in Festival Hall in London.

SOUND FIELD AMPLIFICATION

In this method, many individual microphone-amplifier-loudspeaker channels are located on the wall and ceiling boundaries of a performance space. There may be as many as 100 or so of these channels, and each one is operated at fairly low gain. Sound impinging on a microphone is reradiated at a level corresponding to a reflection from a surface *less absorptive* than the actual boundary. In this way, the room becomes more live and reverberant. Let us work out an example.

Assume we have a space with the following characteristics: L = 50m; W = 30m; H = 15m and $T_{60} = 1.25$ sec.

Working back from the Eyring reverberation time equation, we can solve for the *average absorption coefficient*, $\bar{\alpha}$.

$$\bar{\alpha} = 1 - \exp(-.16V/ST) \quad (1)$$

In this equation, V is the room volume in meters³, S is the total surface area in meters², and T is the reverberation time. Entering the values yields $\bar{\alpha} = 0.4$ for the room.

We can now calculate the room constant, R , as follows:

$$R = S \bar{\alpha} / (1 - \bar{\alpha}) \quad (2)$$

Solving this equation yields $R = 3600$ meters².

Let us now calculate the reverberant sound pressure level in this room if a sound source is delivering 25 acoustical watts, the peak acoustical power output of a symphony orchestra (1):

$$L_{rev} = 126 + 10 \log(W/R) \quad (3)$$

In this equation, W is the acoustical power in watts. Solving: $L_{rev} = 126 + 10 \log(25/3600) = 104$ dB-SPL

Thus, a symphony orchestra playing in this room could produce peaks in the reverberant field of 104 dB. However, the reverberation time in the room is only 1.25 seconds; ideally, for symphonic music, it should be about twice that amount, or 2.5 seconds.

Let us assume that we have a room of the same dimensions with a reverberation time of 2.5 seconds. Let us solve for the new value of $\bar{\alpha}$ which characterizes this new room:

$$\bar{\alpha} = 1 - \exp(-.16V/ST) = 0.23.$$

The new room constant is 1613 meters², and we now calculate the new reverberant level in the room produced by 25 acoustical watts:

$$L_{rev} = 126 + 10 \log(25/1613) = 108 \text{ dB-SPL}$$

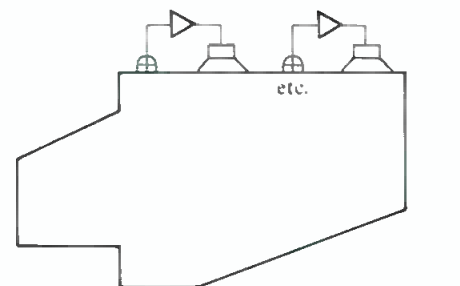

(A) SIDE VIEW

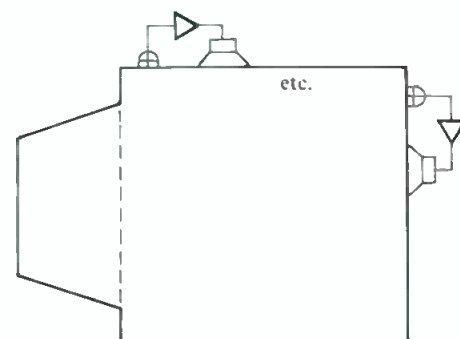

(B) PLAN VIEW

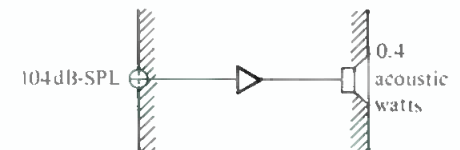

(C) TYPICAL CHANNEL (one of 100)

ACOUSTIC POWER	SPL @ 1 METER (free field)
1.0 watt	109 dB (whole space)
1.0 watt	112 dB (half space)
0.5 watt	109 dB (half space)
0.4 watt	108 dB (half space)

(D) CHART FOR ADJUSTING LEVELS

Figure 1. Details of Philips system for amplifying sound fields.

Why Beyer mics represent a viable alternative to the usual choices in Broadcast.



Beyer MCM Condenser System

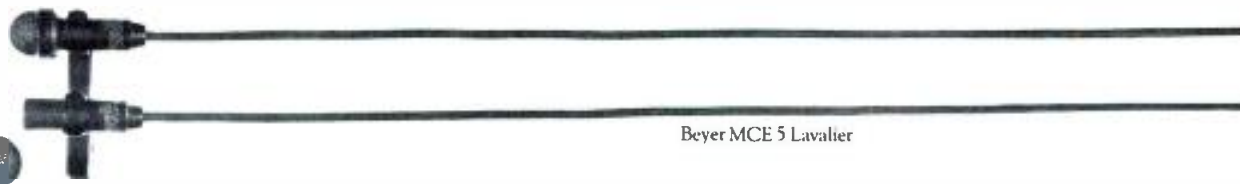

Beyer MCE 5 Lavalier



Beyer M 260

Now there's another high-tech German condenser system.

Until recently, film and broadcast engineers thought only Sennheiser and Neumann made high-quality condenser microphone systems. Now the Beyer MCM Series offers the same German excellence in design and construction, the same kinds of accessories (windscreens, pistol grips, shock mounts) and facilities for 12V and 48V "phantom" powering.

And since the MCM Series studio condenser mic is part of a system which combines power modules and different mic capsules (long shotgun, short shotgun, unidirectional, omnidirectional and figure eight), you get more microphone potential for dollar output.

Like all Beyer microphones, the MCM Series is a truly professional instrument system suited to the widest range of applications in Broadcast/Film and Video post-production.

With lavalier mics, small is not enough.



Electret condenser lavalier mics like SONY's ECM-50 have proven useful for on-camera miking situations because of their reduced size. And while many of these mics offer good performance in a compact size, the Beyer MCE5 also provides extended frequency response (20 to 20,000 Hz) and durability in an even smaller format (diameter: 7 mm / length: 23 mm).

To optimize its compatibility with a variety of broadcast and film applications, the tiny black MCE5 is available in different configurations for powering interface and includes a system with accessories like windscreens, expansion mounts etc.

At Beyer Dynamic's ultra-modern manufacturing facility in West Germany, we hand-build virtually all of our microphones in the most evolved state of fine German engineering.

There's more than one way to bring out the warmth in an announcer's voice.



Broadcast engineers choose the E-V RE20 for many vocal announcing situations because of its wide frequency response (45-18,000 Hz)* and smooth sound. Beyer Dynamic's M 260 also provides the extended frequency response (50-18,000 Hz) and warmth required for critical vocal applications with one distinct advantage: its reduced size. Its compact and efficient ribbon element captures the warmth traditionally provided by this type of mic. And because it is considerably smaller than a mic with a large moving-coil diaphragm, the M 260 provides a natural, balanced sound image in a portable format that won't obscure copy or take up valuable space in the studio.

The Beyer M 260 has its own custom-designed ribbon element to optimize the mic's performance based on its Broadcast applications.

The Dynamic Decision

beyerdynamic

*Extracted from competitive promotional literature or advertising.

*Documentation supporting specific comparative claims available upon request.

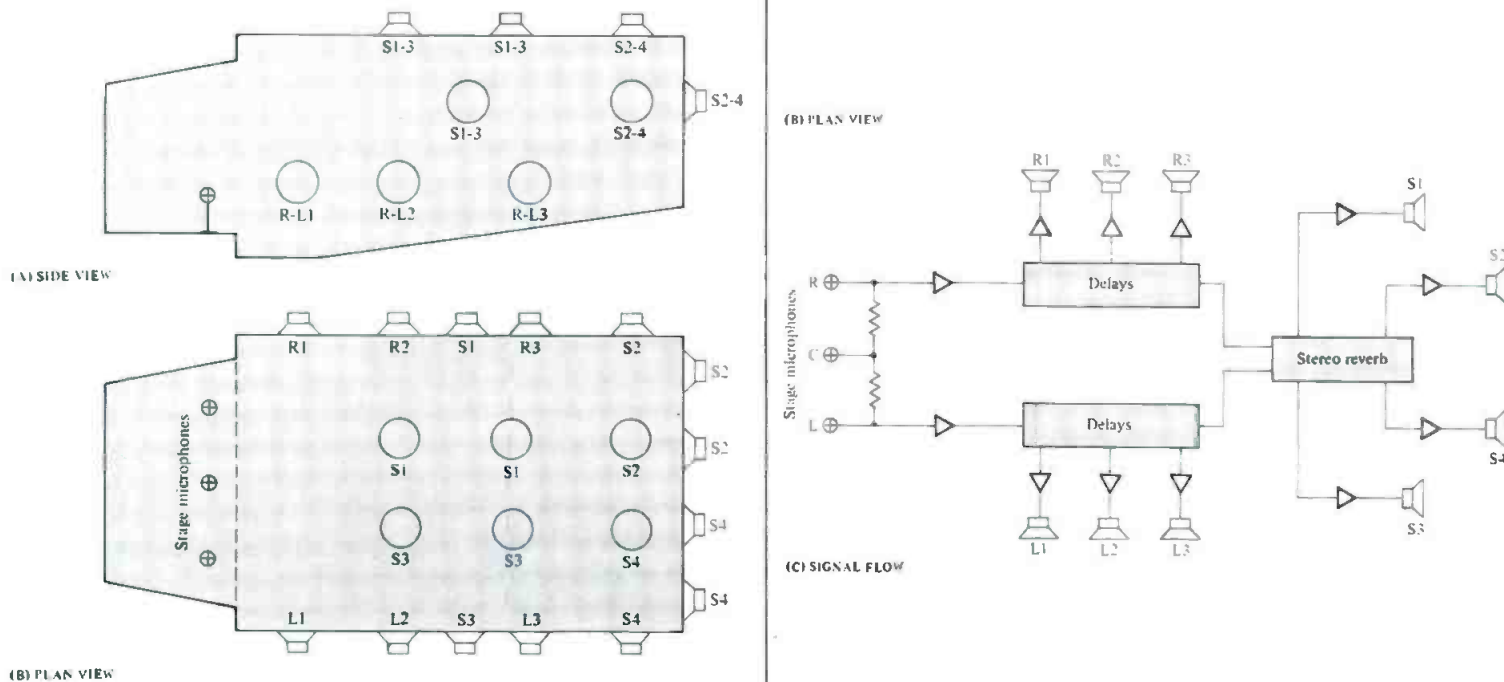

Figure 2. Details of a system for sound field modelling.

This new level is 4 dB greater than that observed in the original room, and if we are to simulate the effect electronically we will have to add to the room, via loudspeakers, peak-power capability some 4 dB greater than 25 watts.

$$\text{Power}_{\text{total}} = 25 \times (10^{.4}) = 63 \text{ watts.}$$

Since $63 - 25 = 38$ watts, we must add to the reverberant field a total of 38 acoustical watts when the normal acoustical level peaks out at 25 watts. If we split the load into 100 channels, each channel has only to deliver 0.38, or approximately 0.4 acoustical watts on peaks.

Each of the 100 channels would have its level adjusted as shown in FIGURE 1. Both microphones and loudspeakers are located at wall or ceiling boundaries. When the microphone is in a 104 dB sound field, the electrical gain in the channel is adjusted so that the loud-

Only Swintek GIVES YOU A CHOICE

in wireless microphone systems

- Choice of mics—Beyer M500, Shure SM57, SM58, SM78, SM85
- Choice of finishes—chrome, black chrome or gold
- Integral antenna or rubber duckie
- Systems for hand held mics, lavalier mics, electric instruments or ENG/EFP/LPTV

Unsurpassed field-proven reliability assures the high audio quality that professionals demand. VHF high band and narrow RF signal bandwidth permit numerous systems to be simultaneously used on nearby frequencies without interference or receiver desensitizing by local TV or radio broadcast signals. All metal construction assures durability and RF shielding. dB-S companders permit wide dynamic range without unnatural compression. Swintek—the proven performers.

Swintek
TELECOMMUNICATIONS DIVISION

1180 ASTER AVENUE, UNIT J / SUNNYVALE, CA 94086
(408) 249-5594 / TELEX 172-150 SWINTEK SUVL

Circle 17 on Reader Service Card

Time in Your Grasp ...

The Studer time code system for highly precise synchronization of stereo recorders

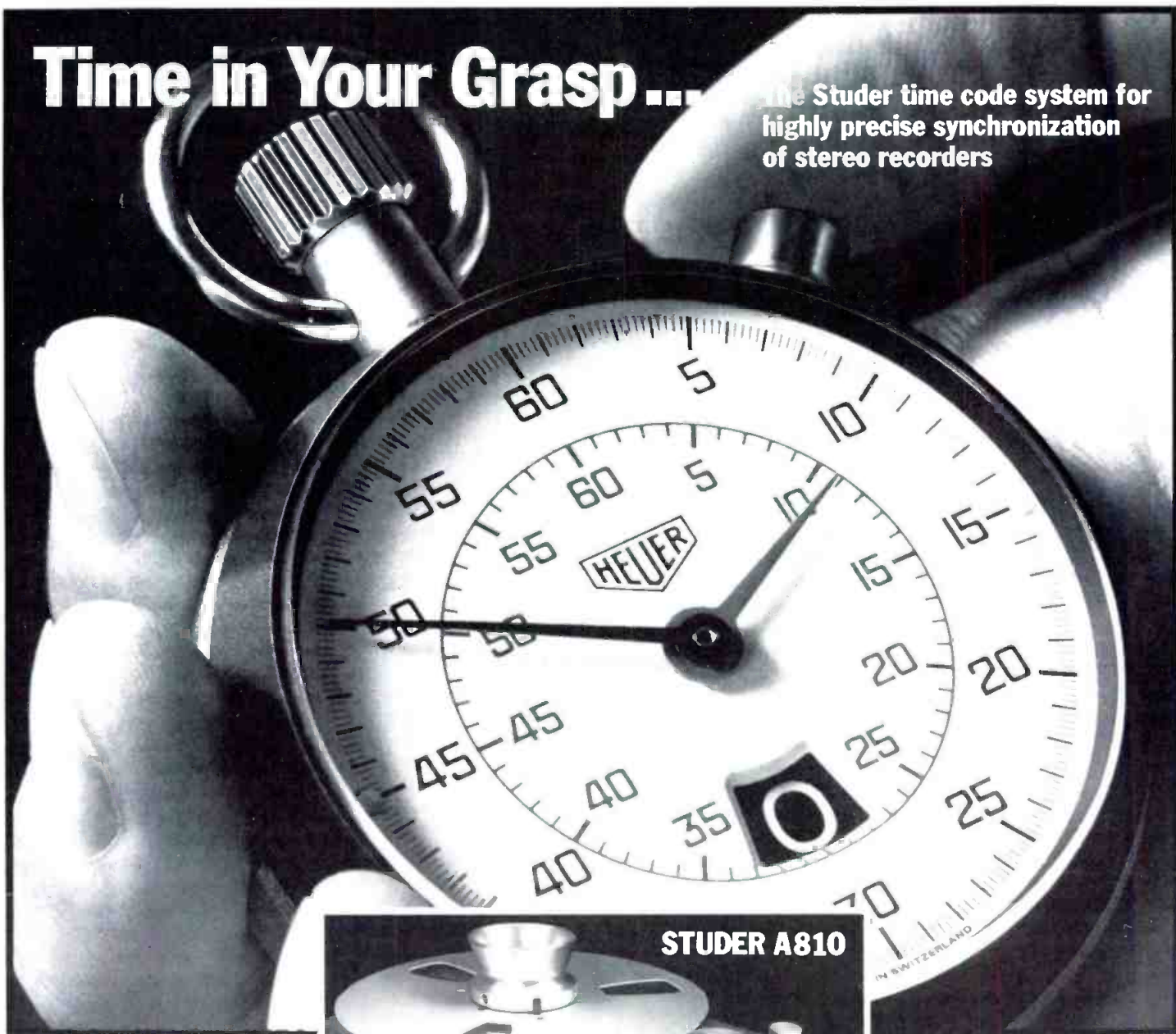

STUDER A810

The new Studer A810 points the way to the future; now even two-channel 1/4" stereo recorders may be perfectly synchronized. Precise SMPTE time code synchronization and maximum crosstalk rejection are attained by separating time code heads from audio heads, and by using a microprocessor-controlled delay. Studer has finally solved the problem of synchronizing stereo machines!

Until now SMPTE-code synchronizing of video-audio, film-audio, or audio-audio has been restricted to multi-channel machines. But such linkups pose no problem for Studer's A810 time code recorders. Designed for maxi-



imum system flexibility, the A810 has a fully digital control system for both the tape transport functions and audio electronic alignment. And, for the first time in the history of audio recording equipment, the A810 offers complete data exchange to peripheral equipment via serial interface. The bus-compatible A810 is ideally suited to complex automation tasks, and the A810's flexible modular concept allows simple, cost-effective changeover to specialized configurations.

We'll be glad to send you more information on the analog and digital capabilities of Studer's new A810 - the audio recorder with a grip on the future.

STUDER REVOX

Studer Revox America, Inc. • 1425 Elm Hill Pike, Nashville, TN 37210 (615) 254-5651
Offices: Los Angeles (213) 780-4234 • New York (212) 255-4462 • Dallas (214) 760-8647 • Canada: Studer Revox Canada, Ltd.

Circle 47 on Reader Service Card

www.americanradiohistory.com

Noise Suppression & Power Protection



Model PS-1

The PS-1 is a power line conditioning unit designed to protect audio equipment from high voltage transients and RF interference. Three neon lamps indicate relative phasing of the line, neutral and ground connections. A latching relay helps to avoid amp speaker damage due to power up transients generated after a temporary loss of power. Ask your local music dealer for more details.



**Linear & Digital
Systems, Inc.**

46 Marco Lane, Centerville, OH
45459 (513) 439-1758

Circle 18 on Reader Service Card

The Affordable

Digital Real Time Third-Octave Spectrum Analyzer

- Full 30 Bands • Six Memories • Quartz Controlled "Switched Capacitive Filtering" to eliminate drift • Ruggedized for Road Use • Microprocessor Controlled • Built-in Pink Noise Source • "Flat," "A," or "User Defined" Weighted Curves may be employed
- ROM User Curves Available.



MODEL 30
Affordable at just **\$1,895.00**

GOLD LINE

P.O. Box 115 • West Redding, CT 06896
(203) 938-2588

SEND FOR COMPLETE LITERATURE:

NAME _____
COMPANY _____
STREET _____
CITY _____
STATE _____ ZIP _____

Circle 19 on Reader Service Card

speaker produces a free-field level of 108 dB at 1 meter. In so doing, it is radiating 0.4 watts, and the entire ensemble of 100 channels will radiate 40 acoustical watts.

The gain of this system is 4 dB; that is, with the system turned on, the reverberant sound field increases by 4 dB. In the process, the reverberation time has been increased by a factor of 2. Philips points out that the maximum gain such a system can handle without adverse effects is given by:

$$\text{Gain}_{\text{max}} = (n + 50) / 50,$$

where n is the number of channels.

The *greater* the number of channels, the *lower* the gain at which each one has to work, and the less the tendency for the aggregate system to ring, or resonate, at particular frequencies. In short, the room and system will behave more like an acoustically live space. Of course, there must be adequate electrical power to drive each channel to the maximum level expected of it, depending on the kind of musical activity to be performed in the room.

Philips also points out that as little direct sound as possible from the stage should enter the microphones, since the intent of the approach is only to amplify the diffuse reverberant field of the room.

SOUND FIELD MODELLING

In the preceding example, electroacoustics was employed to liven a room, but not to make it seem larger than it really is. With sound-field modelling, a fairly small, acoustically dead space may be transformed into a room much larger as well as more reverberant. FIGURE 2 shows how this may be accomplished. Views A and B show side and plan views of an auditorium, while C shows the electronic signal flow diagram. Stage microphones pick up the sound to be processed, and it is important that these microphone inputs be well isolated from the amplified and processed sounds in the house. Acoustical feedback can be a problem if care is not taken here.

In laying out such a system, the designer chooses a target acoustical space and then simulates its early sound field characteristics as well as the onset of reverberation. As with the previous example, the more loudspeakers there are, driven at low levels, the more natural the effect is likely to be. Since time delays, which are the essential cues determining the size of a room, are in the hands of the designer, some remarkable illusions are possible using such a system as this. Typically, a space can be made to seem much larger than it really is by using initial delays characteristic of much larger rooms.

The advent of digital reverberation devices has greatly simplified the implementation of systems like these, since they can provide, in a single package, the necessary early reflections as well as the reverberant field simulation. The better

reverberation devices available today accommodate a stereo (2-channel) input and provide four output channels, two forward-oriented and two back-oriented.

ASSISTED RESONANCE

Like many concert halls built since the Second World War, Festival Hall in London lacked the warmth associated with older, more reverberant performance spaces. The pattern of early reflections was adequate, but the reverberation time was simply not long enough. During the sixties, a large ensemble of Helmholtz resonators was installed above the ceiling. Each resonator housed a microphone, which responded only to the individual tuning frequency of the resonator. The microphone was fed to an amplifier and then to a loudspeaker. In short, each channel amplified only one frequency, providing a moderate increase in reverberation time for that frequency. There are 172 such channels covering the frequency range from about 60 Hz to about 700 Hz. FIGURE 3 shows the implementation of the system (2).

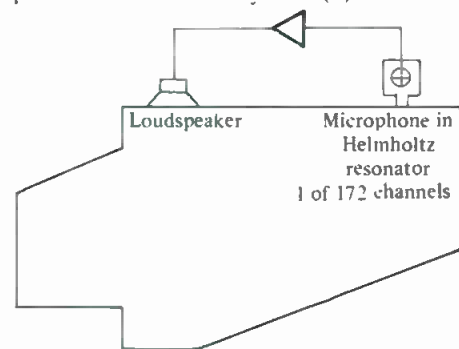

(A) SIDE VIEW

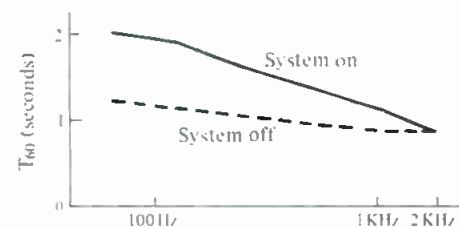

(B) TYPICAL PERFORMANCE OF AN ASSISTED RESONANCE SYSTEM

Figure 3. Assisted resonance.

The reason for using Helmholtz resonators is simply for system stability and ensuring that the channels will not interact with each other.

CONCLUSIONS

We have seen how electroacoustical techniques can be used to simulate natural reverberant fields. In the future, we will probably see more such applications as the cost of digital signal processing continues to drop and as more engineers and architects are called upon to design more flexible performance spaces. ■

REFERENCES

1. Philips Product Bulletin: Multi-channel Reverberation System (published by Audio-video System group).
2. P. H. Parkin, "Assisted Resonance," pp. 169-179. *Auditorium Acoustics* (Applied Science Ltd., London, 1975).

The Problem Solvers:

Articulated Array™ Loudspeakers by Bose®

More and more sound system designers and installers are turning to Bose Loudspeakers for their "problem jobs" as well as their routine requirements. They have found that Bose's Articulated Array™ system offers the coverage and intelligibility they need to reach every seat, in almost any type of room.

The multi-faceted baffle design of the Bose 802-W and 402-W speakers orients each transducer in a precise 3-dimensional relationship. This unique Articulated Array™ system delivers an unusually smooth horizontal radiation pattern, reducing the hot and dead spots caused by conven-

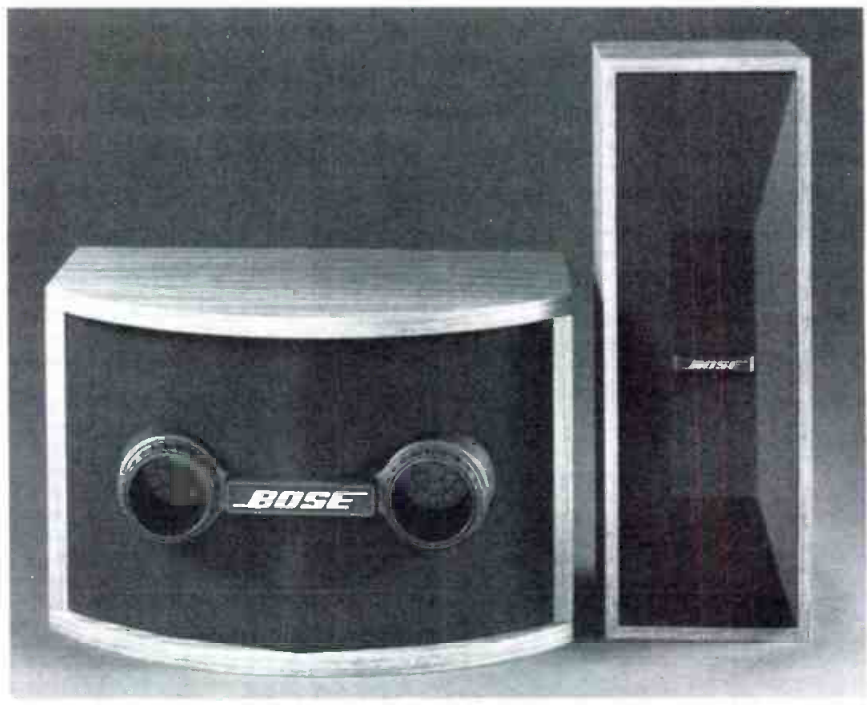

tional horns or columns.

The gradual "skirts" of the vertical radiation pattern provide exceptionally uniform front-to-back room coverage. And the compact, modular design of the 802-W and 402-W enclosures makes it easy to install central clusters and distributed units that meet the needs of a wide variety of room shapes.

Send in the coupon for complete technical data on

the Bose 802-W and 402-W Loudspeakers. Then listen to the 802-W and 402-W, and hear how the technology of Bose's Articulated Array™ system can help solve your next sound installation problem.

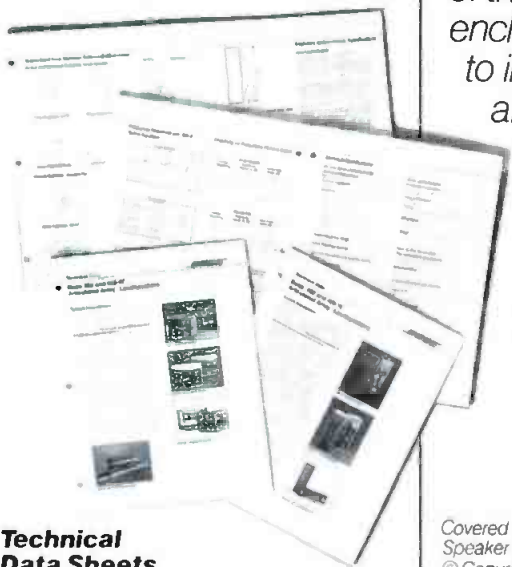

Technical Data Sheets

Covered by patent rights issued and/or pending. Speaker designs are trademarks of Bose Corporation. © Copyright 1982 Bose Corporation.

Bose Corporation, Dept. SE
The Mountain
Framingham, Massachusetts 01701

Please send me the Bose Professional Products Catalog and your technical data.

Name _____

Firm _____

Address _____

City _____

State _____ Zip _____

Telephone () _____

BOSE
Better sound through research.

Theory & Practice

Infinitesimal Calculus

• In England, the Great Plague was taking its heavy toll. Finally, in the year 1665, Cambridge College sent its students home, and remained closed until the plague ended in 1666. A student named Isaac Newton returned to his parent's country home and put that vacation to good use. In rural solitude, he invented the differential and integral calculus of fluxions, formulated the laws of motion and of gravitation, completely explained the motion of the planets, and discovered the nature of light. There has probably never been such a concentrated and brilliant period of scientific exploration and discovery—there may never be one like it again.

Young Newton was eager to solve the ancient problem of planetary motion, but he perceived that a new analytical tool was needed to fathom the problem. From his knowledge of infinite series, he recognized the conceptual possibilities in using mathematical limits. To utilize that unique method of arithmetic computation, he invented an unprecedented kind of mathematics called calculus. With that new tool he succeeded where others had erred, because he could precisely specify, where the others had only speculated. Calculus introduced a method of problem solving which caused a revolution. Since then scientists and engineers in all technical fields have used it to find solutions to their own problems.

The audio field is no exception. While someone might argue that he has been making recordings for fifty years without knowing what a Function is, it must be pointed out that neither the equipment nor the understanding which created it could have existed unless Newton had been there first. All of it was conceived, designed and implemented by people who could think in strict problem-solving terms, and more than likely calculus provided a framework for their thoughts. The analytical thought process does not end after the hardware is built; to do any complex task properly—that is to say, more than superficially—the task must be *understood*. Thus, to best utilize a mechanism devised by a mathematical mind, we must first be able to match wits with its creator and be able to explore it mathematically. And that's becoming more and more true every day in our increasingly programmable world. Calculus was essential to Newton because he needed it as a tool. Similarly each of us needs tools such as calculus to insure that our ways of thinking are applicable to

the problems facing us.

Just why did Newton need calculus? If an object moving at constant speed travels 10 meters in 5 seconds, its speed is 2 meters per second. Simple algebra shows that. So far, so good. But what if the object's speed varies? About fifty years before Newton's vacation, Galileo discovered that an accelerating mass drops $4.9t^2$ meters per second in the first t seconds of its fall. Newton determined the following: when we know the distance an object travels during a period of time, and want to determine its speed at any instant in time within that interval, we would need derivative calculus. Conversely, if we know the speed over some interval for an object travelling at a varying speed, and we want to determine the distance it travels within that interval, we would need integral calculus.

CALCULUS

So, what is calculus? Basically it is the treatment of limits, the utilization of infinitely small quantities, the subdivision of time. It might not appear to be schoolboy stuff, but it's not as hard as it looks. Consider the symbol d as meaning "a small part of." Thus the notation dx means a small part of x ; that is, an "element" of x . We find that these small parts may be considered to be infinitely small, and the process of working with them is called differentiation. The often-learned symbol \int (which is merely a long S), may be called "the sum of." Thus $\int dx$ means the sum of all the small parts of x , or $\int dt$ means the sum of all the small parts of t . Obviously the sum of all the parts makes the whole, and another name for the whole is the integral, and that's what the symbol is called. For historical accuracy, I should parenthetically note that this form of notation was devised by the German philosopher and mathematician Leibnitz who developed calculus simultaneously and independently of Newton; apparently there was some kind of fad or something.

AS THE MICROPHONE FALLS...

Exactly how do infinitesimal increments of time enter the problem? Let's look at the first part of calculus, derivative calculus, with the question of how to find a varying speed, given distance and time. Consider a falling mass—a dropped microphone for example. We know that in t seconds it falls $4.9t^2$ meters. In the first second, it falls 4.9 meters, in two seconds, it falls 19.6 meters, and so on. Thus it has fallen four times further in two seconds as in one. As the microphone falls, its speed increases. Its speed starts at zero and unfortunately reaches its relative maximum as the microphone hits the floor, as any maintenance technician will tell you. To estimate its speed at any time t we could perform separate cal-

Now you hear it...

Model 105

Now you don't.

The Garner Audio Tape De-gaussers are truly the most flexible and thorough audio tape erasers available. With them, you can erase cassettes, reels, and cartridges in just four seconds. And, we guarantee that your erasure will meet the most stringent recording standards. It really is a case of "Now you hear it... Now you don't."

garner

GARNER INDUSTRIES, INC.
4200 No. 48th St., Lincoln, Nebraska 68504
Phone (402) 464-5911

There's more to hear...

Just write Garner Industries for more information:

NAME _____
TITLE/POSITION _____
COMPANY _____
ADDRESS _____
CITY _____ STATE _____ ZIP _____

THE BEST-DRESSED RACKS GO BY THE BOOK.

ALTEC LANSING— the choice of sound professionals for over 50 years.

1674—4-Channel Automatic Microphone Mixer shares gain among individual mics in multi-mic set-up. Increases gain of in-use mics, lowers others for hands-off mixing.

1678—8-Channel Automatic Microphone Mixer with same features as 1674.

1689—2-Channel Mono/Stereo Mixer/Preamplifier. Includes phantom power, mic and line level inputs.

1651—Single Channel Graphic Equalizer with 10 1-octave, active filter sections. Up to ± 12 dB boost/cut with center detented slide controls.

1652—Stereo Graphic Equalizer with same features as 1651 for each channel.

1268—Stereo Power Amplifier. 60+ watts/channel into 8 ohms 20 to 20kHz at less than .03% THD. 200 watts/mono. Optional line transformers for balanced input. Computer protection of amp and load.

1269—Stereo Power Amplifier. 120+ watts/channel, 400/mono, with same performance and features as 1268.

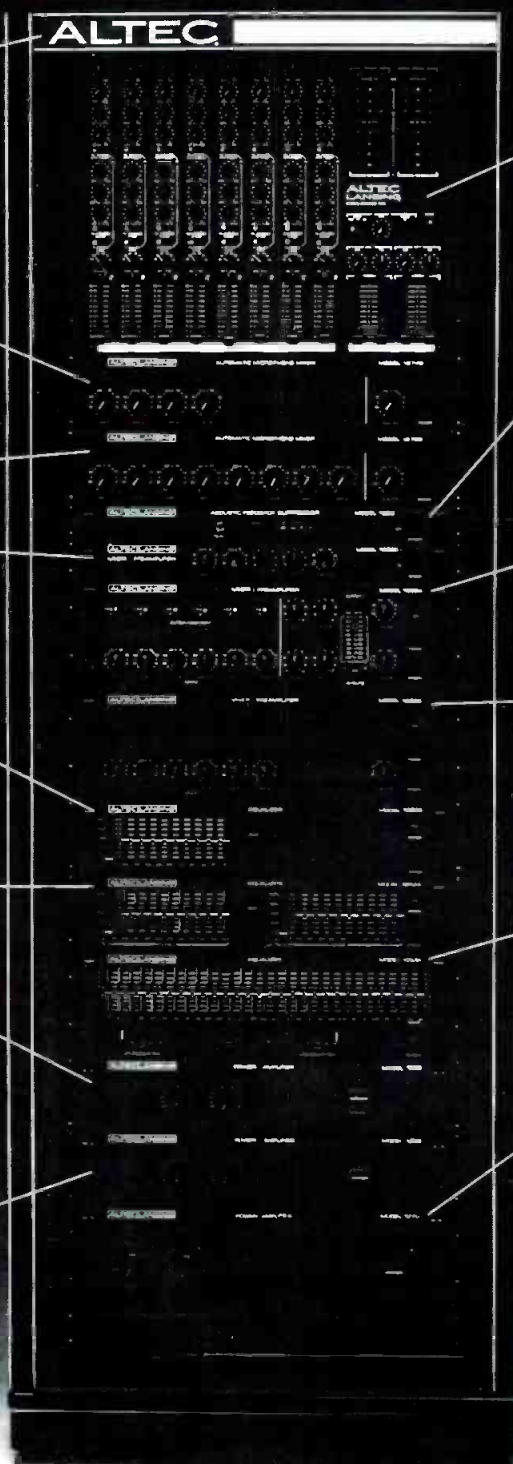

1690—8-Channel Stereo Mixer/Preamplifier for sound reinforcement, recording and mixdown. Linking connectors allow coupling additional 1690s for expanded versatility.

1620—Acoustic Feedback Suppressor automatically detects feedback oscillations, lowers gain and adjusts system to optimum level for hands-off feedback control.

1692—6 in, 2 out Mixer/Preamplifier. Each input with volume, gain, high pass, phantom power and optional remote volume control.

1699—6 in, 2 out Mixer/Preamplifier/Mixer Extender. "Link out" feature provides 12 independent channels when paired with 1692.

1653— $\frac{1}{3}$ -Octave Graphic Equalizer with 29 active filter sections, 25 to 16kHz. 18 dB/octave continuously variable high and low pass filters.

1270—Stereo Power Amplifier. 400+ watts/channel into 4 ohms, 800 into 8 ohms/mono. Computer circuits protect amp and speakers. Fan cooled. VI limiter helps the 1270 handle the toughest loads.

Altec Lansing's Black Rack Book—featuring Altec's new line of power amps, mixers, equalizers and related electronics. Precision-matched for optimum sound power and control, Altec's components work together for increased system efficiency and performance. For the ultimate in custom-tailored sound for your system, send the coupon to:

**ALTEC
LANSING**

Black Rack Book
P.O. Box 3113
Anaheim, CA 92803

Name _____

Address _____

City, State, Zip _____

Occupation _____

DB

Circle 25 on Reader Service Card

culations a short time apart, say at 1 and 1.1 seconds. The distance travelled during that interval would be $4.9(1.1)^2 - 4.9(1)^2 = 5.93 - 4.9 = 1.03$ meters. So, an estimate of its speed would be 1.03, 10.1, or 10.3 meters per second. But, that is actually the average speed during the interval from 1 to 1.1 seconds. A shorter interval would be more accurate. From 1 second to 1.01 second, the distance travelled is 0.0985 meters and the average speed is 9.85 meters per second. Obviously a general solution, rather than specific time-interval approximations, is required. Newton's brilliant idea dawns on us—let's employ infinitesimally small intervals!

IT MUST BE MAGIC

Let's examine a time interval from t_1 seconds to t_2 seconds, which has a duration of $t_2 - t_1$ seconds. The distance the microphone falls is $4.9t_2^2 - 4.9t_1^2$ meters and the speed at the end of the interval is:

$$(4.9t_2^2 - 4.9t_1^2) / (t_2 - t_1).$$

Simplifying:

$$4.9[(t_2^2 - t_1^2) / (t_2 - t_1)],$$

$$4.9[(t_2 + t_1)(t_2 - t_1) / (t_2 - t_1)].$$

We obtain a speed of:

$$4.9(t_1 + t_2).$$

Now watch closely, this is the part where the rabbit comes out of the hat—as the interval gets smaller and smaller, t_1 gets closer and closer to t_2 , and the quotient approaches $4.9(t_2 + t_2)$; therefore, the speed of the falling microphone after t seconds

is $4.9 \times 2t$, or in general, $9.8t$ meters per second. Thus we prove that speed is proportional to time. In the earlier case, at a time of 1 second, the actual speed is 9.8 meters per second; our early estimates were high because the intervals were not infinitesimal; they were too large. Most importantly, we have developed a general method to derive the speed of any object, even one with a formula of motion different than $4.9t^2$. That method is differentiation. We say that the first derivative of the distance function, $4.9t^2$, yields the velocity function, which is $9.8t$. Moreover, the second derivative of the distance function is the acceleration function. Thus for a free-falling microphone 9.8 meters per second is the constant acceleration due to gravity; more than enough force to dent a windscreen. This analysis has been rather informal—Newton became rich and famous by bravely stating the theorem which everyone else had hitherto informally wondered about. He said: "The n th derivative of x^n is $n \cdot x^{n-1}$, for any positive integer n ."

It should be remembered that in our expressions for the first derivative, the value of t_1 approached a limit of t_2 ; however it could never actually equal t_2 because during a zero time interval from t_1 to t_2 the microphone would move a zero distance and a calculation of the speed quotient would be meaningless. Remember Zeno's paradoxes? If not, stick around.

Now the converse—how to find dis-

tance, given varying speed, we know that an object with varying speed travels different distances during equal increments of time during its motion. Without infinitesimal calculus the solution to the problem can only be approximated. If an object is moving at t^3 meters per second, it initially had a speed of zero and thus it moved at least zero meters. At the end of 2 seconds, when its speed is 8 meters per second, it will have moved at most 8×2 or 16 meters. Thus the total distance it moves in 2 seconds is somewhere between zero and 16 meters. As far as it goes, that is a valid guess, but not an especially precise one. As in the case of the falling microphone, we gain accuracy by considering a greater number of shorter intervals because the speed will vary less over a shorter period of time. If we divide the time interval of 2 seconds into 4 intervals, we can add together the estimates of individual distances travelled to find the total distance travelled. During the first $\frac{1}{2}$ second interval, its least speed is zero and its greatest speed is $\frac{1}{8}$ meters per second. Thus the least distance it could have travelled is zero, and the greatest distance is $\frac{1}{16}$ meters. Similarly calculating the distances in each of the four intervals, and adding all the terms, we find the least distance is: $0 + \frac{1}{16} + \frac{1}{16} + \frac{1}{16} + \frac{1}{16} = \frac{4}{16} = \frac{1}{4}$ meters and the greatest distance is: $\frac{1}{16} + \frac{1}{16} + \frac{1}{16} + \frac{1}{16} = \frac{4}{16} = \frac{1}{4}$ meters for 2 seconds, which is a better estimate than our first approximation of 0 to 16 meters. Divid-

THE CONVERTIBLE.



Omni, cardioid, bi-directional or something in between. Flat or low cut, highly sensitive or with a 12 dB pad. The DC 63 turns into anything you please, but it will always be true to its sources.

MILABTM
PROFESSIONAL MICROPHONES

Manufactured by CTAB, S-265 00 Åstorp, Sweden

BELGIUM Trans European Music 02 569 18 23 · FINLAND Studiotec 90 556 252 · FRANCE MCI France 1 227 25 95 · GERMANY EMT-Franz 07825 1011 · HONG KONG Studier Revex 5-412050 · JAPAN Continental Far East 03 583 8451 · NEW ZEALAND General Video 4-872-574 · NORWAY Pro-Technic 02-460554 · SPAIN Singleton Production 2203800 · SWITZERLAND Audio Bauer 01 64 32 30 · UNITED KINGDOM AVM Audio Video Marketing 0632 893092 · USA West Carr International 213 621 7898 · USA South Swedex 404 881 9981 · USA East Facel 212 370 0032

Circle 21 on Reader Service Card

"The Electro-Voice Sentry[®] 500 is a monitor by design."

FIRST TIME ADVERTISED!

Greg Silsby talks about the New Sentry[®] 500 studio monitor...

Everyone expects a studio monitor system to provide a means of quality control over audio in production.

True, other audio test equipment can supply you with valuable data. But that data by itself is incomplete and only displayed in visual form.

Only a true studio monitor speaker system can deliver an accurate indication of audio quality in... audio! After all, this is the language of the trained ear and doesn't require a complex interpretation process.

I believe the Electro-Voice Sentry 500 Studio Monitor System will meet your every expectation.

What's a "studio monitor?"

The term "studio monitor" is often a misnomer. It's easy to tack a label on a box and call it a "studio monitor" without including the best precision engineering available, and careful attention to application design. Too often, these all-important considerations are traded-off for such marketing reasons as high cosmetic appeal, a particular type of popular sound, and low component manufacturing cost. While all of this may translate into high profit margins for the manufacturer it does nothing to produce a reliable standard for audio testing and evaluation.

Linear frequency response

The Sentry 500 follows the well-established Electro-Voice tradition of combining the most advanced engineering and manufacturing technology available. The Sentry 500 has been carefully thought-out and built to meet the specific needs of the audio professional. Like the smaller Sentry 100A, the Sentry 500 provides linear response throughout its range (40-18,000 Hz \pm 3dB). In fact, because the two systems share this linearity, program material may be mixed on one, sweetened on the other, with



complete confidence in quality. Acoustic "Time Coherence" (the synchronous arrival of acoustic wave fronts from both high and low-frequency drivers) has been maintained through careful crossover design and driver positioning.

Constant Directivity

The Sentry 500 is a Constant Directivity System, benefitting from years of E-V experience in the design and application of constant directivity devices. Utilizing a unique E-V-exclusive high-frequency "Director", the Sentry 500 provides essentially uniform coverage over a 110° angle from 250Hz on up to 10kHz and 60° dispersion from 10kHz clear out to 18,000 Hz! And it does this on both the vertical and horizontal axes. This means the "sweet spot", once a tightly restricted area large enough for only one set of ears, has been broadened to allow accurate monitoring by the engineer, producer, and talent—all at the same time. That's what we call Constant Directivity.

A monitor by design

To qualify as a truly accurate test device, a monitor speaker system must faithfully reproduce the wide dynamic range required by today's music and current digital recording techniques, and do it with low distortion. This is no problem for the Sentry 500 which combines the high efficiency of an optimally-tuned Thiele-aligned cabinet to the brute power handling of Electro-Voice Sentry components. Consider what you get with proven

E-V components in the Sentry 500: the Sentry 500 will deliver 96dB at one meter with only one watt and yet will handle 100 watts continuous program material with 6dB of headroom. That's 400 watts on peaks! The same Super-Dome[™]/Director combination which maintains uniform dispersion of linear response out to 18kHz also handles a full 25 watts of program power or 5 times the power handling capacity of most "high powered" tweeters. After all, tweeters should convert electrical energy to acoustic energy—not to smoke and fire.

The Sentry 500 is another no-nonsense Electro-Voice Sentry design with the incredible performance and credible price you've learned to expect from E-V. I'd like to tell you the rest of the Sentry 500 story and send you the complete Engineering Data Sheet. Write to me: Greg Silsby, Market Development Manager/Professional Markets, Electro-Voice, Inc., 600 Cecil Street, Buchanan, Michigan 49107.

Market Development Manager,
Professional Markets

 **Electro-Voice[®]**
SOUND IN ACTION[™]

a **gulton** company

Circle 27 on Reader Service Card

www.americanradiohistory.com

SENNHEISER

MKH416TU/P48U.....\$553.-	MD421U.....\$208.-
MKH816TU/P48U.....729.-	MD441U.....289.-
HMD224.....139.-	HD414.....50.-
ME88.....162.-	Other Models..Call

— Ship & Ins. 3.00 first item + 50c each additional item —

MICROPHONICS P.O. Box 37, Brooklyn, NY 11204
 (212) 438-6400

CIRCLE 17 ON READER SERVICE CARD

ing the time into smaller-and-smaller intervals yields more-and-more accurate distance estimates. Eventually, as the intervals become infinitesimal, the lower and upper estimates converge at the actual distance travelled, which in this case happens to be 4 meters. This method of dividing an interval into smaller parts to form sums, and determining what happens to those sums when the parts are infinitesimally small, is that of the definite integral. In this case, we have taken an infinite number of terms of the basic equation: distance = (speed)(time) to obtain the integral of a function, namely, the integral of t^3 is $t^4/4$. Previously, we showed that velocity is a derivative of the distance. Now we see that the definite integral of velocity is the change in distance. That relationship would eventually lead any reasonably bright school kid to propose the first fundamental theorem of calculus: "The definite integral of the derivative of a function over an interval is the difference in the values of the function at the ends of the interval." After that was settled, unravelling the mysteries of planetary motion was a piece of cake.

Capitalizing on these fundamental theorems, the motion of the planets and all physical motion is readily identified and analyzed with simple calculus. But the importance of gravity notwithstanding, calculus is also the primary tool by which the audio engineer comes to terms with his subject to both completely comprehend that which is familiar to him, and explore the unfamiliar. A simple integral is a straightforward and empirically accurate result, a light at the end of the tunnel. Just as Newton invented calculus because he needed an analytical tool to fashion the statements of his discoveries, calculus still remains as an essential engineering tool by which audio theory is brought down to audio reality. Throughout the too-often ambiguous field of audio, a little calculus always brings a straight answer; it's the essence of the unification of theory and practice.

ON YOUR MARK, GET SET

Oh, let's not forget Zeno, the B.C. Greek philosopher who was an early expert at becoming thoroughly confused about questions of continuity and infinity. Consider the Achilles paradox: Achilles is running a race. In order to cover the remaining distance he must first cover half the remaining distance. But before he covers that distance he must first cover half of its distance, and so on. Hence, at any time, Achilles still has at least half the distance to go and thus is

never able to finish the race. Actually, because of the same problem between the starting line and the course midpoint, he was never able to begin the race either. Or consider the arrow paradox: An arrow is in flight. At any instant the space occupied by the arrow is equal to the length of the arrow. Since the arrow cannot occupy two spaces at once, the arrow cannot undergo motion at any instant. Since time is composed of instants, no motion of the arrow is possible. The Achilles problem apparently shows that a continuous model of a phenomenon is self-contradictory, and the arrow problem apparently shows that a discrete model is equally self-contradictory.

That spells paradoxical trouble for the audio world. Consider a stylus in a record groove— in the same way that Achilles could never start (or finish) a race, the stylus could never start (or finish) its spiral. And given the arrow's dilemma, how could a digital tape recorder ever advance to its next sample? On the other hand, the arrow could never be in flight since Zeno taught us that the arrow could never leave the bow. Since the arrow paradox is thus fallacious, maybe digital recordings are okay, and analog recordings, whose existence is clearly impossible to prove, must be an illusion. It's just like the record companies to charge \$9 for something imaginary. On the other hand— well, you know all about calculus, so you figure it out. ■

Do You Know Where?

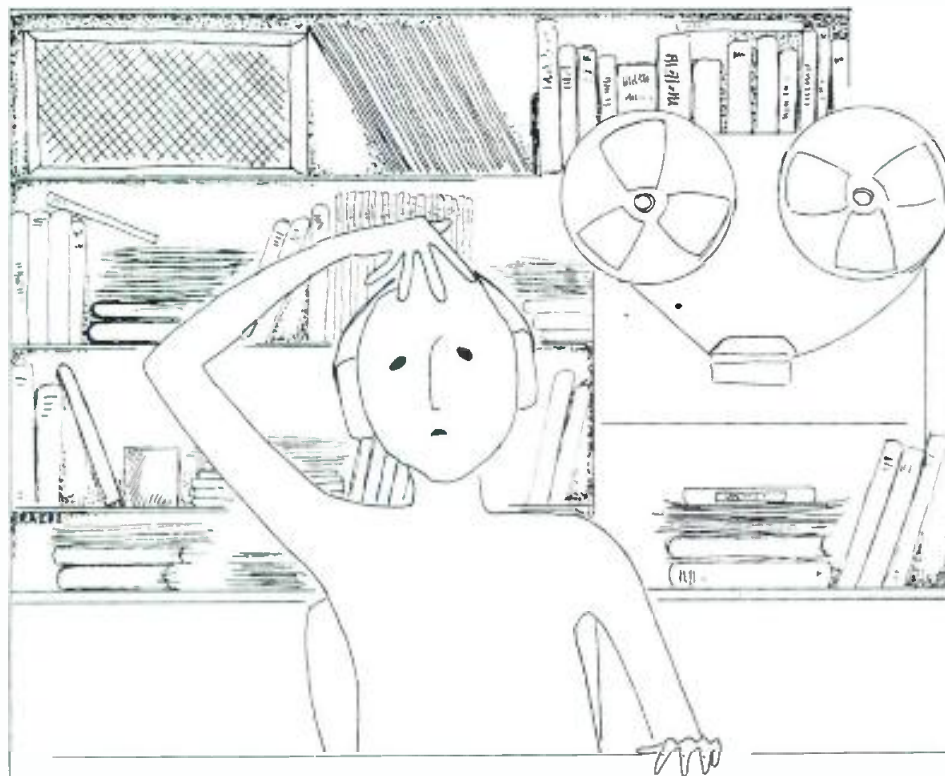

Have you misplaced your db again? Our high quality, royal blue vinyl binders keep 12 copies of db neat and handy for ready reference.

Just \$9.95, available in North America only. (Payable in U.S. currency drawn on U.S. banks.) ORDER YOURS NOW!!

Sagamore Publishing Co., Inc.
 1120 Old Country Road
 Plainview, NY 11803

YES! Please send _____ db binders @ \$9.95 each, plus applicable sales tax. Total amount enclosed \$ _____

Name _____

Company _____

Address _____

City _____

State/Zip _____

One of 24 Reasons Why You Should Buy The Dolby® SP Series.

The Dolby SP Series provides up to 24 tracks of Dolby A-type noise reduction in only 12¼" of rack space. Each channel features a plug-in Cat. No. 230 carrier card containing controls, LED display, interface circuitry, and a plug-in Cat. No. 22 NR module.



The SP Series' combination of compact size, ease of operation, high performance, and new features make it ideal for equipping new recording facilities and upgrading existing ones. Regardless of the number of tracks, the SP Series features:

- Separate regulated power supply unit with electronically-controlled output protection.
- Low-noise fan cooling.
- User-selectable option of "hard" or electronically-buffered bypass of individual tracks and of all tracks simultaneously.
- Balanced and floating input stages.
- Output stages drive either single-ended or balanced 600-ohm loads at levels up to +28 dB (19.5 V) before clipping.
- Ultra-low-distortion input and output amplifiers.
- Discrete FET switching for reliable, noise-free routing of audio signals.

DD Dolby®

Dolby Laboratories Licensing Corp., 731 Sansome Street, San Francisco, CA 94111. Telephone 415-392-0300
34 Clapham Road, London SW9 0AP. Telephone 01-720-1111
"Dolby" and the double-D symbol are trademarks of Dolby Laboratories Licensing Corp. S82/4220

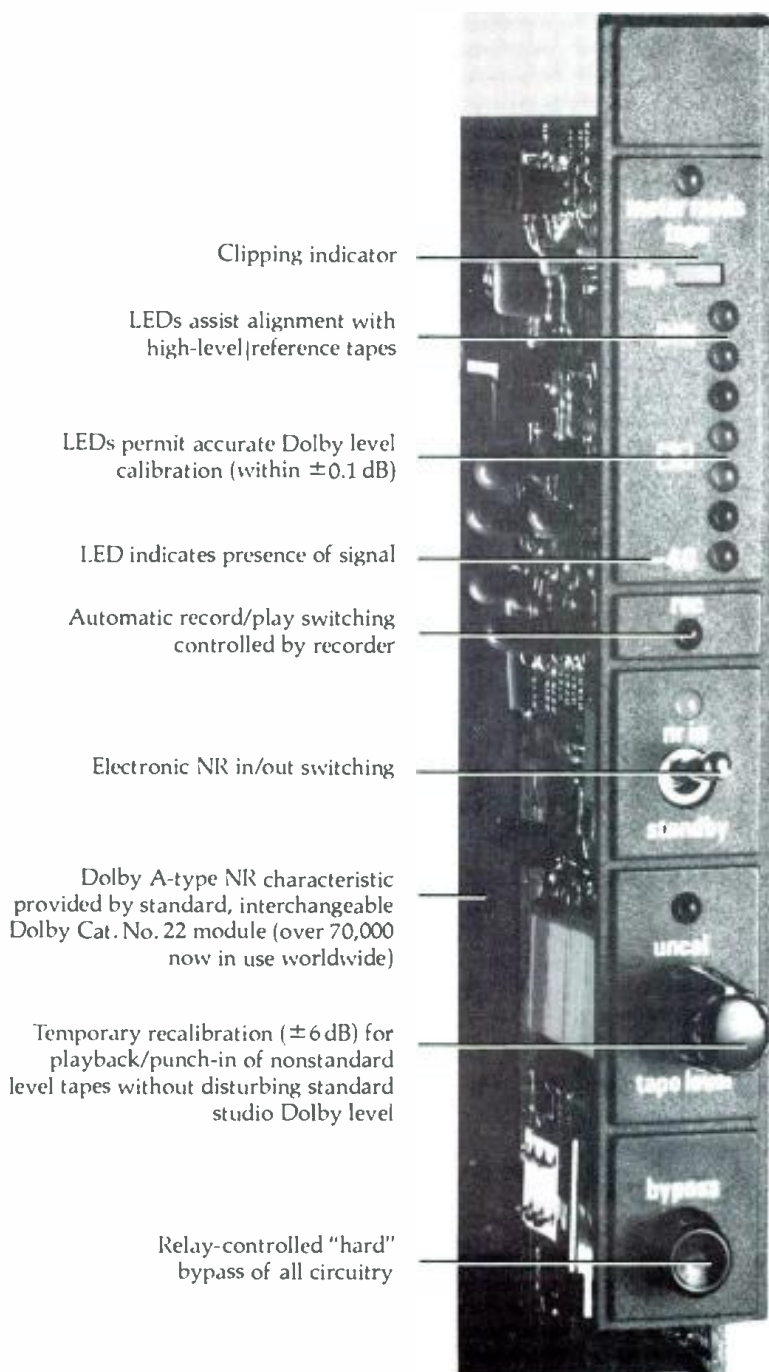

Clipping indicator

LEDs assist alignment with high-level reference tapes

LEDs permit accurate Dolby level calibration (within ± 0.1 dB)

LED indicates presence of signal

Automatic record/play switching controlled by recorder

Electronic NR in/out switching

Dolby A-type NR characteristic provided by standard, interchangeable Dolby Cat. No. 22 module (over 70,000 now in use worldwide)

Temporary recalibration (± 6 dB) for playback/punch-in of nonstandard level tapes without disturbing standard studio Dolby level

Relay-controlled "hard" bypass of all circuitry

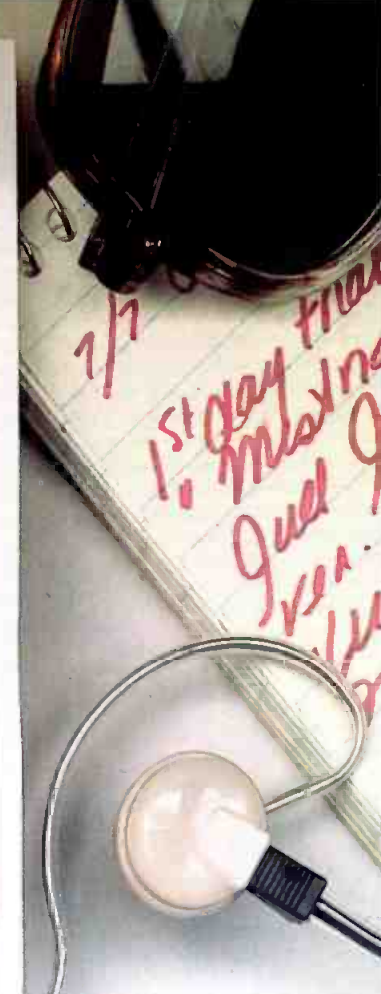

**Amid the hostility, the confusion, the competition,
one microphone stands above the crowd.**

The SM63.

No matter how rough things get in the field, the Shure SM63 Omnidirectional Dynamic Microphone gives your crew the whole story with a lot less handling noise than any microphone in its class. When Shure's engineers developed the SM63 and SM63L (with longer handle), their objective was to create a high-output, lightweight microphone perfect for the needs of electronic news journalists.

With the SM63's patented internal mechanical isolation system reducing undesirable handling noise, its high output and smooth extended frequency response lets your story come through crisp and clear. Its omnidirectional polar pattern prevents boominess that is often encountered during close miking situations. And its overall lightness makes continuous hand-held ENG/EFP assignments less fatiguing, without sacrificing ruggedness. Even its profile is small and elegant so it won't obscure faces on camera.

The output of the SM63 is a full 6 dB higher than comparable hand-held interview microphones.

And there are even more precision-engineered refinements. A highly effective internal humbucking coil rejects strong magnetic fields encountered around lights and other broadcast situations. And when things get really tough, the Shure-developed *VERAFLEX*[®] grille is virtually impervious to rust, moisture and dents. This system includes a highly effective internal anti-wind and -pop filter; and for more adverse conditions, a dual-density two-layer windscreen also is supplied.

The Shure SM63. The hard-working microphone for the working press.

For more information on the complete line of professional broadcast products, call or write Shure Brothers Inc., 222 Hartrey Ave., Evanston, IL 60204, (312) 866-2553.

SHURE[®]

THE SOUND OF THE PROFESSIONALS[®]...WORLDWIDE

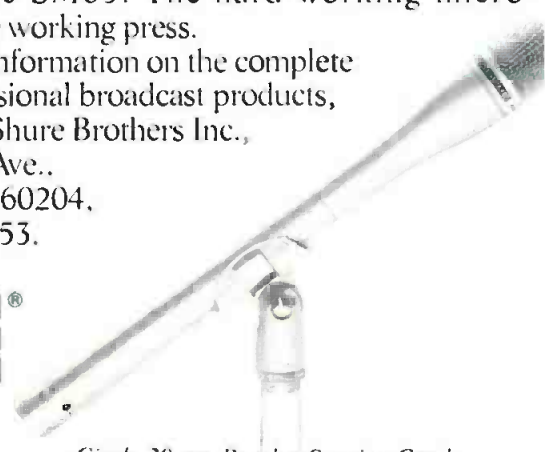

Circle 29 on Reader Service Card

If Flag 1 D' S if flag 1 is set, go to D'

0 S data which will be presented if flag 1 = clear.

RTN S return immediately to the original return, do not execute any more of this subroutine.

LBL D' S name of entry if Flag 1 is Set.

CLR Flag 1 S clear flag 1 so that it will never come here again.

1 S data which will be presented if flag 1 = Set

RTN S return to original program.

This will work fine if we have a way of initializing the flag before the initial running.

INITIALIZATION

Our original program of last month mentioned the requirement to initialize the main program. The suggestion was to do this by hand. Again we may ask about an automated process for the initialization. Let us now define an initialization routine called "Begin." Since we only expect to run this code once before the filter, this should really be the very beginning of the program. Since the Label A is a natural beginning, let us rename our original program so that the name A from last month is now called A'. The user will never have to access A' since the iterations are internally controlled. The user will only enter the program at our new A which contains the initialization. We now have the following:

LBL A S new beginning of main program

SET Flag 1 S indicates to generator program that this is the beginning.

10 S initial pointer number

ST 0 S place in Reg 0, the D-pointer

LBL Inx S local label for iteration to clear delay line

0 S number to be placed in delay line

ST IND 0 S use pointer to clear a memory register.

OP 20 S increment D-pointer

0 S select Reg 0 in SBR E

SBR E S test for modulo end of line

10 S number for comparison to follow

x-t S place in t-register

RC 0 S place D-pointer in X-register

IF x≠t Inx S if not done yet continue by jumping to Label Inx

9 S real initial value of D-pointer

ST 0 S first value of D-pointer

GOTO A' S now do main program.

There are a number of interesting issues with regard to this initialization routine. We implemented the clearing of the delay line in a manner which does not appear to be natural or simple. The first observation which one could make is that we did not use the key function CLR MEMs (clear all memories). One reason for this is that the memories also contain the coefficients and this would then require us to re-enter them each time the program was run.

The next observation is that we used the old SBR E for turning the end of the delay line pointer to the beginning of the line. Direct coding would have been easier since we only need to run through the delay line once from Reg 10 to Reg 19. The issue here is that we wanted to use the routine which contained the specification of the line length. Had we direct coded it, the delay line length information would have had to be located in two places! Forgetting to change it in one place would have resulted in an error. This kind of thinking is often called "structured" programming. We must not take a simple approach because a large program eventually becomes unmain-tenable.

As we mentioned in the previous article, good programming practice requires that we test sections. To test the initialization routine, we do not need the main program A' and could replace it with a stop (R/S); however, we do need the subroutine E. An interesting test would be to place dummy numbers in Regs 10 through 20. The initialization routine should clear those from 10 through 19 but not the data in Reg 20 since it is not part of the delay line. A complete listing to date is shown below. Because we have placed the main routine A' after the initialization routine A, we do not have to use a GOTO A' since the flow will just fall into A'.

Notice that as we modify the code and add new routines we do not have to keep track of where things are located. The instruction SBR E (call to SBR E) works regardless of the actual locations of SBR E. The Label allows the calculator to find it regardless of its actual location. This is called position independent coding. A more direct form might have been SBR 132 which means go to the SBR at location 132. This is position dependent code since SBR E must then begin at this point.

TEST CASE

We are now ready to run a real test case. Let us take a filter with the follow-

```

086 76 LBL
087 15 E
088 42 STD
089 04 04
090 73 RC*
091 04 04
092 32 X/T
093 01 1
094 09 9
095 77 GE
096 12 B
097 01 1
098 00 0
099 72 ST*
100 04 04
101 76 LBL
102 12 B
103 92 RTN

```

Subroutine for implementing the wrap-around effect for all pointers.

```

104 76 LBL
105 14 D
106 87 IFF
107 01 01
108 19 D*
109 00 0
110 92 RTN
111 76 LBL
112 19 D*
113 22 INV
114 86 STF
115 01 01
116 01 1
117 92 RTN
118 00 0

```

Generator subroutine for creating an impulse at t = 0 of value 1.

```

104 76 LBL
105 14 D
106 87 IFF
107 01 01
108 19 D*
109 01 1
110 92 RTN
111 76 LBL
112 19 D*
113 22 INV
114 86 STF
115 01 01
116 00 0
117 92 RTN
118 00 0
119 00 0

```

Alternative generator subroutine (replaces above) for creating a step input beginning at t = 1 of value 1.

Now! A balanced high-level output oscillator with the lowest distortion.

This is oscillator performance that's totally advanced, totally Tektronix! Depend on the new SG 505 Option 2 for balanced, high level output in the studio or at a transmitter site. It outputs a sine wave with less than 0.0008% THD, the lowest residual distortion of any oscillator on the market today.

Complex measurements are made automatically in tandem with the AA 501 Distortion Analyzer. These two TM 500 plug-ins can be mounted in the same or separate mainframes, or transferred to a portable mainframe for use in the field.

No other manufacturer offers this kind of flexibility: two separate devices that make one powerful package, side-by-side or miles apart. Still fully automatic, even when separated.

New state-of-the-art performance, by every measure! The SG 505 Option 2 features a completely balanced output configuration for compatibility with highest-performance audio systems. Source impedances are selectable among 600, 150 and 50 ohms. And when you're testing for clipping



margin or headroom, the SG 505 generates high level output of +28 dBm into a 600 ohm load and +30 dBm into a 150 ohm load.

Answers come quickly with the AA 501. No level setting, tuning or nulling required. Measurements are precalculated via digital processing and displayed on the LED readout automatically.

Part of the family: TM 500. These two plug-ins share the configurability that TM 500

is famous for: over 35 different plug-ins for a host of test and measurement requirements. Six mainframes provide bench, rackmount and portable packaging, each with built-in power supply.

Call the Tektronix National Marketing Center today for specifications, pricing and applications information. Technical personnel can answer your questions, accept your order and expedite delivery. Direct orders

include operating manuals, 15-day return policy, full Tektronix warranty and service back-up.

**Order toll free:
1-800-426-2200
Extension 13**

In Oregon call collect:
(503) 627-9000 Ext. 13

**The Answer
By Any
Measure**

Tektronix
COMMITTED TO EXCELLENCE

```

000 76 LBL      015 00 0
001 11 A       016 71 SBR
002 86 STF     017 15 E
003 01 01     018 01 1
004 01 1      019 00 0
005 00 0      020 32 X:T
006 42 STD    021 43 RCL
007 00 00     022 00 00
008 76 LBL    023 22 INV
009 23 LNX    024 67 EQ
010 00 0      025 23 LNX
011 72 ST*    026 09 9
012 00 00     027 42 STD
013 69 DP     028 00 00
014 20 20

```

Initialization routine when entering program for the first time. When finished, it continues at V the next instruction in the sequence.

ing coefficients located in Reg 30 through Reg 39.

Reg No.	Contents
30	1
31	2
32	3
33	4
34	5
35	5
36	4
37	3
38	2
39	1

We press Go to A' R S and the world begins. It is a good practice to press RST (reset) before a run just to clear everything. Notice that the result is the impulse response, as follows:

```

-1
-2
-3
-4
-5
5
4
3
2
1

```

The data appears reversed but remember that Reg 39 is the coefficient for the least delay and Reg 30 is for the most delay. At the start of running the program you might think that something was wrong because no data comes out. The program takes a very long time to run. With each "improvement" it becomes still slower. It takes about 2 to 3 minutes for the impulse to pass through the complete delay line!

You may try other filter coefficients and you will become convinced that the impulse response is just the coefficients from the filter. For this reason, the coefficient listing and the impulse response are always considered equivalent for an FIR filter. This is not true for IIR.

```

029 76 LBL      058 01 01
030 16 A'      059 01 1
031 01 1      060 71 SBR
032 44 SUM     061 15 E
033 00 00     062 73 RC*
034 00 0      063 01 01
035 71 SBR    064 65 *
036 15 E      065 73 RC*
037 43 RCL    066 03 03
038 02 02     067 95 =
039 71 SBR    068 44 SUM
040 14 D      069 02 02
041 72 ST*    070 01 1
042 00 00     071 44 SUM
043 00 0      072 03 03
044 42 STD    073 43 RCL
045 02 02     074 01 01
046 43 RCL    075 32 X:T
047 00 00     076 43 RCL
048 42 STD    077 00 00
049 01 01     078 22 INV
050 03 3      079 67 EQ
051 00 0      080 13 C
052 42 STD    081 43 RCL
053 03 03     082 02 02
054 76 LBL    083 99 PRT
055 13 C      084 61 GTD
056 01 1      085 16 A'
057 44 SUM

```

Main routine for computing I output filter value for each iteration.

STEP RESPONSE

The step response, like the impulse response, is the filter's output for a particular type of input. A step is defined as 0 for all negative t , and 1 thereafter. We would thus need to make a new generator program for this class of input. A little thought, however, will show that the step response could be made if we just switch the 0 and 1 data from the impulse response. This will give us 0 at $t=0$ and 1s thereafter. The impulse was the reverse, it was 1 at $t=1$ and 0s thereafter. This change is so simple that we do not need to really write a new program. Location 109 becomes a 01, and location 116 becomes 00.

Now when we run the program we get a much different type of result. The first output is, of course, 0 since we did not actually put in the "ideal" step. Our step begins at $t=1$ whereas the ideal usually begins at $t=0$. Mentally we can shift the result by 1 unit. The observed response is the following:

```

0
-1
3
-6
-10
15

```

```

-10
-6
-3
-1
0
0
0

```

The filter's output after 10 inputs becomes a set of 0s. This is usually not the case but is an artifact of the particular coefficients. After a long time has passed, the step is actually nothing more than the DC of value 1. Hence, the output is the sum of the coefficients or the DC gain. Our particular example had coefficients whose sum was 0.

SPECIAL NOTE

The above program has assumed that the reader has a printer for his calculator. This convenience is shown in the program. For those who do not have it, it is suggested that the PRT (print) instruction be replaced with either an R S (stop and then manual restart) or PAU (Pause) which will flash the answer on the display for 1 second and continue automatically.

Next month we will continue with this program using a sinewave input to get the frequency response. And finally, we will explore the effect of coefficients on the filter's characteristics. ■

Sound With Images

Tape—Another Common Denominator Between Audio & Video

• Recently, **db** Publisher Larry Zide and I were invited, along with other members of the consumer and professional audio press, to visit the huge chemical complex known as BASF, in West Germany. During our visit to Ludwigshafen (a town on the opposite bank of the Rhine from Mannheim), two things became apparent to all of us. First, we all take for granted the availability of magnetic recording tape without giving much thought to where it comes from and how it's made. Secondly, magnetic tape provides another bond between audio and video; without it neither technology would exist.

With that in mind, I thought you might find it interesting to hear about how tape is actually made—from the raw materials that go into it to the finished audio or video tape product—as the processes were explained to us on this recent trip.

Aside from minor changes in formula-

tion and particle types, audio, video and even computer tapes are really very much the same. They all consist of a plastic base and a magnetic coating: a binder blended with microscopic-sized magnetizable pigments. These days, the base is a polyester film. (I can remember when it was an acetate or even a paper base, which gives you some idea of *my* age.) The magnetic pigments are primarily made of iron oxide or chromium dioxide, while the binders tend to vary in composition.

BASF, we learned, produces its own iron oxide and chromium dioxide for magnetic tapes. Very few so-called tape manufacturers actually do this. Most buy the oxides from chemical concerns such as BASF, Dupont and others. The oxide particles are shaped like tiny needles: their lengths ranging from 0.3 to 1.0 microns, depending upon the type of oxide. Their diameter is generally less than 0.1 micron.

In order to achieve the magnetic and electrical properties expected of today's tapes, oxide particles and binder material must be blended homogeneously. This is done in a milling room, where batteries of slowly turning ball and tube mills produce a thoroughly mixed dispersion of the oxide within the binder. FIGURE 1 shows a portion of one such milling room. In order to achieve the desired quality of oxide dispersion, such technical factors as the diameter of the milling balls, milling time, viscosity of the oxide, binder and solvents, outside temperature and even, at times, the order in which the components are introduced to the mixture, all play an important part.

THE CRITICAL COATING PROCESS

Once the magnetic oxide dispersion is ready, it is stored in large vats and is continuously agitated, using nitrogen as pro-

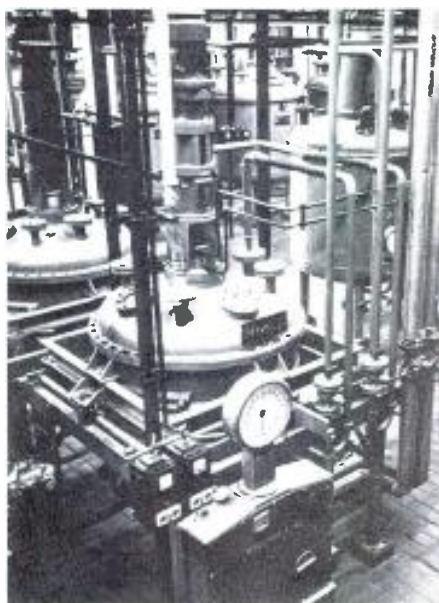

Figure 1. One of the milling rooms at BASF, where oxides, lacquer and solvents are mixed to form the dispersion that ultimately coats magnetic tape.

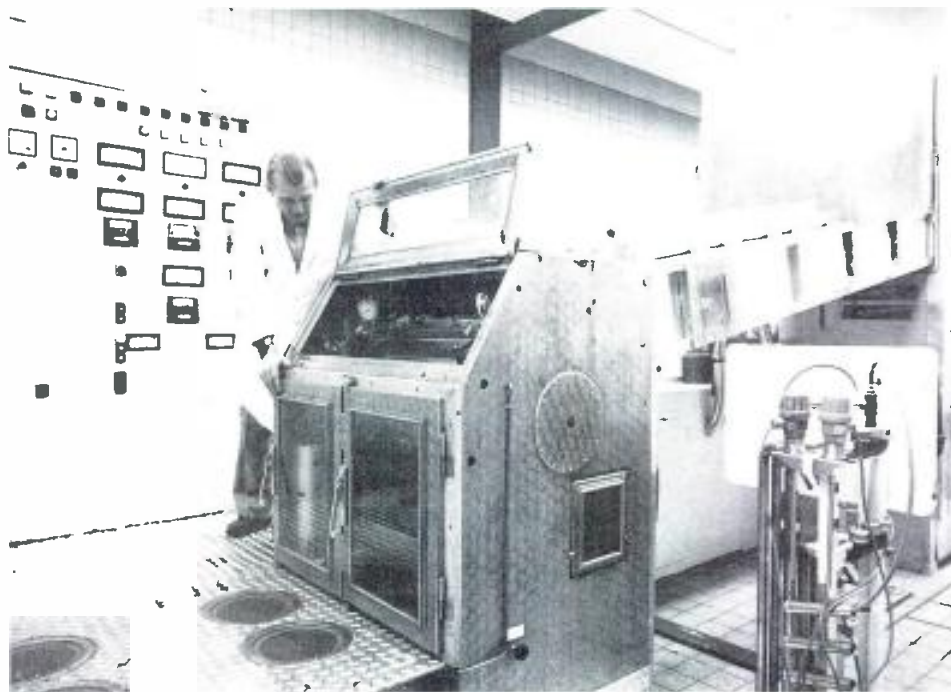

Figure 2. A view of part of the clean room in which critical tape coating takes place. These rooms are sealed off from the rest of the plant.

protective gas until it is released under pressure through fine filters into stainless steel pipes. The pipes lead the material to the machine that will coat the dispersion onto the tensilized polyester plastic film. The coating operation itself is an extremely critical one and is carried out under dust-free conditions. In liquid form, the dispersion is considerably thicker than it will be after it solidifies or dries, at which time it will range in thickness from 3 to 22 microns, depending upon the type of tape and its application. Given such dimensions, it's easy to understand that dust particles (even those measuring a mere thousandth of a millimeter) imbedded in the dispersion during coating would have the effect of a large spot of non-magnetic material.

The coating machines must therefore operate in a clean-room environment which is sealed off from the rest of the plant. During our visit, we could only observe what was going on in the coating rooms through panes of glass which sealed us, and the rest of the factory, out of this critical area. A portion of one coating room can be seen in FIGURE 2. This room, which is maintained at closely regulated climatic conditions, can only be entered through an air lock. Prior to actual coating, the plastic film which serves as the base material is cleaned again to remove any foreign particles that may have clung to it during its manufacture or storage prior to use.

During the coating process itself, the moving film passes under a coating head which deposits a thin layer of dispersion. Evenness of coating thickness within close tolerances is what distinguishes high quality tapes from lesser grades. A perfectly even coating, we learned, depends as much on the exact positioning of the rollers over which the plastic film travels as on a heavy, vibration-free base for the coating head.

Immediately after the coating has taken place, and while the deposited dis-

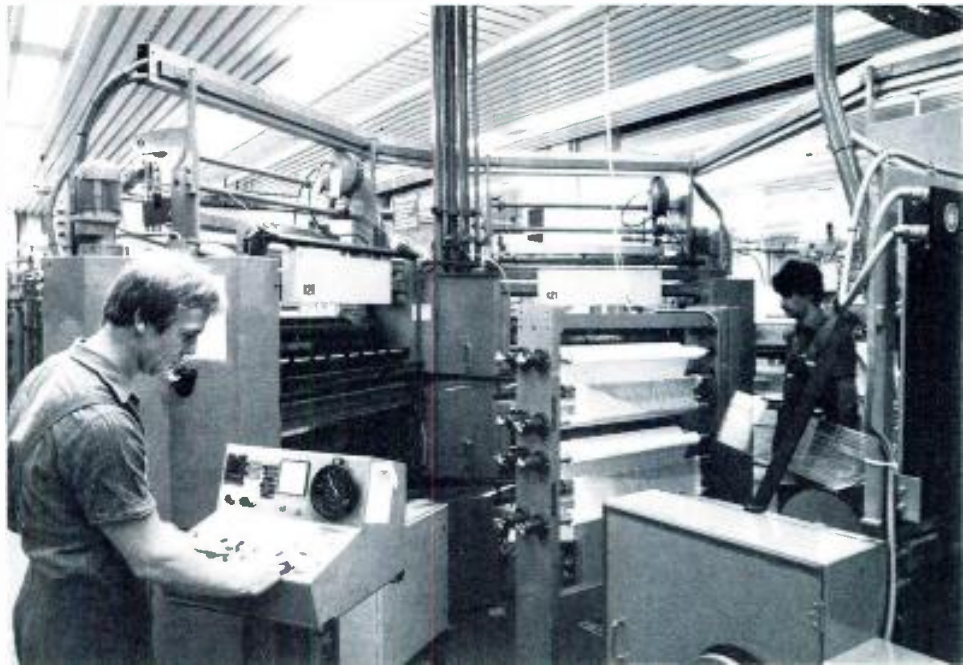

Figure 4. An overall view of a complete slitting station.

persion is still wet, it is passed beneath a strong magnet which orients each needle-like magnetic particle in the same direction: the direction in which the sheet of tape is moving. This achieves what is known as a "magnetic preference" direction and improves the electro-acoustic quality (in the case of audio tapes) considerably, according to BASF.

The coating containing the wet solvents is then passed through a dryer which is located directly beyond the coating head. To enhance the drying process, the coated film travels over guide rolls several times the actual length of the dryer. Solvents released during this drying process are passed through activated charcoal and are recycled. When the tape emerges from the dryer it is subjected to pressure and heat rollers which smooth and polish the coated surface. This polishing is extremely important in insuring best possible magnetic and mechanical contact between tape and tape heads. The coated film then passes a counter and an electro-acoustical pre-tester and it is next wound into a roll known as a butt roll. FIGURE 3 shows a butt roll being wound as the tape emerges from the drying tunnel.

Next, the butt rolls are slit into required tape widths with an accuracy of one hundredth of a millimeter. What we have come to call "half inch" video tape is actually somewhat narrower than that, when slit to the precise international standard of 12.65 millimeters. That works out to an English measurement of 0.498 inches. So-called 1/4-inch audio tape, if precision slit per existing standards, measures 6.3 millimeters in metric terms, which corresponds to 0.248 inches and cassette-tape is slit to a metric measure of 3.81 millimeters, which corresponds to 0.150 inches. Various aspects of the precision slitting operation are shown in FIGURES 4 and 5.



Figure 5. Close-up view of tape slitting operation.

At this stage of the manufacturing process, in addition to the tests which were made during oxide production, dispersion, milling and coating, electro-acoustical and mechanical quality control procedures and tests are introduced to qualify the tapes for sale in the various categories for which they are produced.

After all the criteria for frequency range, maximum output level, harmonic distortion, sensitivity, signal-to-noise ratio and print through, tape thickness and the quality of slit edges are met, the tapes are released for final processing. In the case of video tapes, several additional characteristics have to be checked, such as video signal-to-noise ratio, dropouts per given length of tape (this is extremely important in checking computer tape as well), chrominance and radio frequency output.

The final phase of the actual manufacturing process is loading. In the loading rooms, large pancakes of wound tape are automatically spooled into video or



Figure 3. This machine is winding a butt roll from coated tape as it emerges from the drying tunnel.



Figure 6. The London Philharmonic conducted by Thomas Beecham at the historic 1936 magnetic tape recording. The hall, still in existence, seats under 1,000.

audio cassette housings or onto conventional open-reels. In the case of audio compact cassettes, the finished loaded cassettes move on to yet another testing station where they are tested automatically for the screws fastening the housing, shell measurements, correctness of coating, presence of all required parts, action of the pressure spring, and proper torque. Cassettes and reels that pass these inspection points move on a conveyor to be labeled and packaged.

FINAL STATISTICAL QC

There still remains one important step in the entire process that must be performed before the packaged, finished lots can be released for shipment. After packaging, a prescribed number of units are statistically sampled for another complete round of tests.

I suspect that having seen what it takes to produce a high-quality reel of audio or video tape, those of us who visited the BASF facilities are likely to have just a little more respect for that next reel or cassette of tape we absent-mindedly unwrap and pop onto our video or audio recorders, whether in a studio or broadcast environment or on a home machine.

As you may already know, BASF invented magnetic audio tape way back in 1934. In 1936, the London Philharmonic Symphony was recorded in the private concert hall which is located on the grounds of the BASF facilities in Ludwigshafen (the concert hall is still used for various cultural events and for the benefit of BASF employees and their families). We heard that tape recording played back in that very concert hall and were given a cassette dub of part of the performance. Listening to the scratchy, distorted performance of Mozart's 39th symphony (DC was still used to bias tape; we Americans can claim credit for introducing high-frequency bias even if tape itself was a European invention), I could not help thinking just how far we—and magnetic tape—have come in the forty-six years since that concert took place. ■

225 W per Channel In Only Three Rack Spaces. The UREI 6300.

And, 750 watts in mono! That makes the UREI 6300 the most powerful amplifier of its class. More important than its compact size is its clean sound... in fact, you could compare the sound to the most esoteric *audiophile* amplifier. But, the 6300 is built to give the same performance day after day, night after night.

The 6300 was designed for the rigors of the working sound professional. The rugged chassis and extruded front panel make the 6300 extremely roadable and the continuously variable fan helps assure reliable operation. A totally modular chassis assures fast, easy service in case of difficulty with this rugged and reliable amplifier.

Electronically, the 6300 is also built to UREI quality standards, to provide extremely clean and transparent sound. Hear the UREI 6300 at your professional sound dealer today, or contact UREI for more information.

UREI

From One Pro to Another

United Recording Electronics Industries
a URC Company
8460 San Fernando Road
Sun Valley, California 91352
(213) 767-1000 Telex: 65-1389 UREI SNVY
Canada: E. S. Gould Marketing, Montreal



Looking Ahead, or, Another Year Has Gone Down the Tubes

DEPENDING ON YOUR MOOD, you might want to cross one or the other of those catchy little phrases off the top of the page. For here it is December again—time for the optimists to be looking ahead to an exciting new year, while the pessimists spend their time cataloging all that was wrong with the old one.

Certainly, 1982 will not be remembered as one of the truly great years, unless you get off on depressing statistics. The unemployment rate seems to show every sign of catching up with the interest rate, and for those with money left to spend, everything seems to cost more and be worth less.

However, there are signs that all might not be lost. As mentioned last month, the mood at the recent AES convention was optimistic. Not wildly so, but at least people weren't hanging themselves in the bathrooms. And although a single AES show is not really a barometer of the coming economic climate here in Audioland, perhaps it is at least a sign that we may not all drown before the storm is over.

Nevertheless, some of us may have to change course slightly in order to stay afloat. For many of us, professional audio has long been synonymous with the record business, and the emerging "everything else" of audio has been ignored. Of course, the tendency to ignore change is not unique to audio. Many companies grow up doing things a certain way, and eventually develop a "we've *always* done it this way" mentality. When the times change, the company policy doesn't. Another company comes along with a new approach, and the cycle repeats. Some companies get the message—others don't. Take a look at Detroit (our favorite whipping boy). The auto makers *still* haven't figured out that the market for motorized trash cans has dried up. We sometimes wonder how many auto moguls will go down the tubes blaming everyone but themselves for the trouble they're in.

It doesn't have to be so. Take a look at our—until recently—second-favorite airline, Pan Am. (Our first was "anyone else.") The line's dependably rotten service

alienated many frequent flyers to the point of deliberately avoiding any flight number that began with "PA" (that's Pan Am, not Public Address). The company was in big trouble, and did something about it. Unlike Detroit, they didn't blame the rising price of fuel, the Japanese, Reaganomics, or the stars. They looked a little closer to home, and got back in touch with reality—and their customers. No doubt they've still got a long way to go, but at least they're no longer destroying themselves from within, a la Braniff.

Meanwhile, back here on the ground, how many audio pros blame all their woes on forces beyond control? Before we're accused of being "out of touch" ourselves—Yes, we are aware that times are bad. But they're not (yet) so bad that we have no control over them. We may not have as much control as we'd like, but then, we probably never did. It's just that when times were better, we could all afford to be a little more casual about things. Nowadays, we've got to pay a little more attention to staying on the road, and a little less to enjoying the scenery.

In the recording studio, that may mean looking beyond the megabuck album production for other ways to pay the rent. For the manufacturer, it may mean expanding the product line into other market areas. For all of us, it means keeping alert to changing times.

Record labels no longer speculate huge budgets on all those not-quite-ready-for-prime-time acts. Studio owners no longer go out and buy one of everything, just for the hell of it. And anyone who has been making a nice living as an exclusive caterer to the Fantasyland crowd is in big trouble.

Some economists tell us that all of this bad is really good. They advise us that because of the prevailing economic weather, we must either shape up or go out of business. For those who survive the storm, no doubt this will turn out to have been good advice. But for those who don't...?

Here at **db**, we're planning to stay afloat. What about you? JMW

ONE 1510A WILL SHOW YOU EVERYTHING YOU NEED TO KNOW AND MORE... AT A PRICE YOU CAN AFFORD

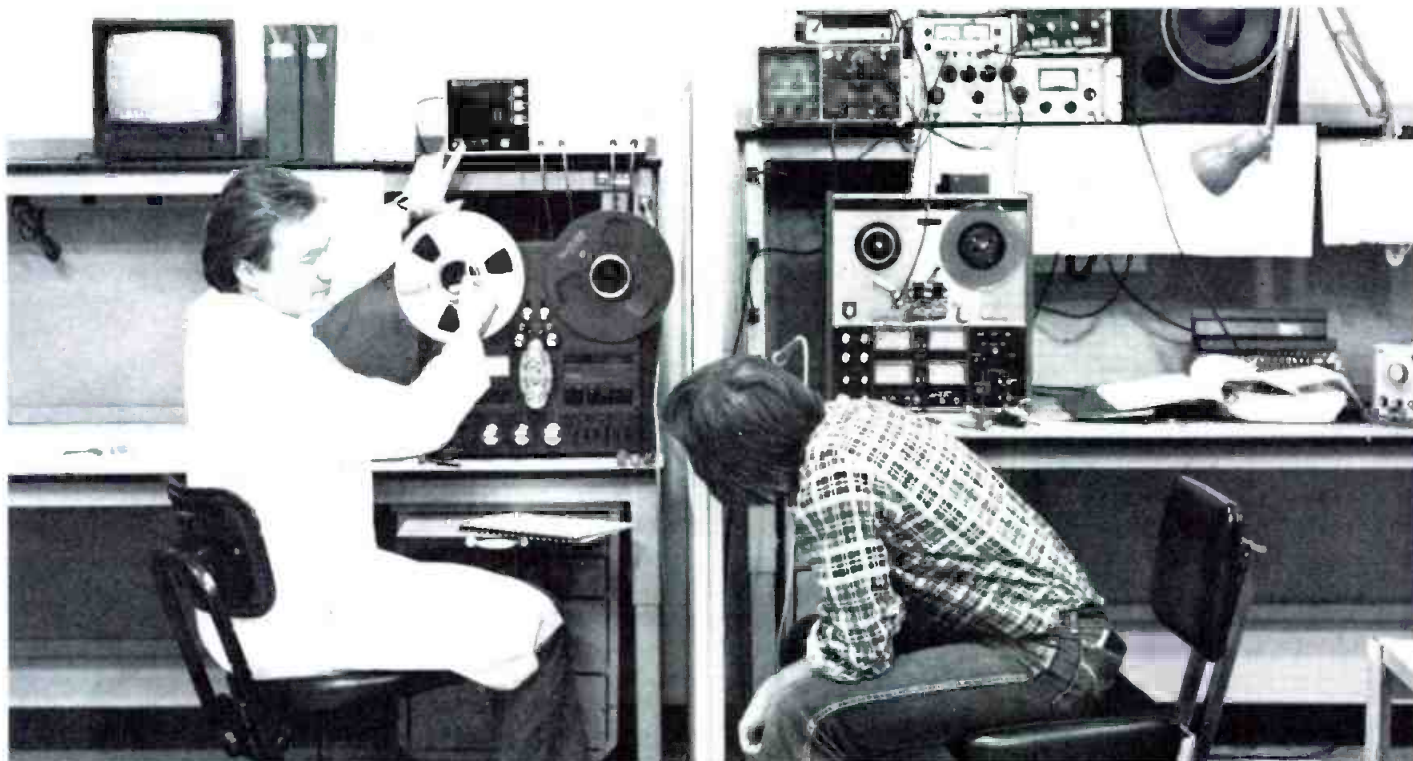

We cut the weight. The price. And we added features.

Like balanced and floating high-level outputs (-70 to +30 dBm/600 Ω). High speed spot-frequency sweeps. A Maximum Output Level test for checking tape saturation at selected frequencies. Programmable 0.1 dB step attenuators. A 75 μ sec pre-emphasis circuit for phono cartridge adjustments and a new Dropout detector that counts each dropout and automatically collates the data into four categories.

With the NEW 1510A Audio Test System it is now easier and cheaper than ever before to measure and collect data right at the source. Before it becomes a problem. Without the additional burden of paperwork.

Break through to a whole new dimension in test and measurement. Join the standard by which others are measured.

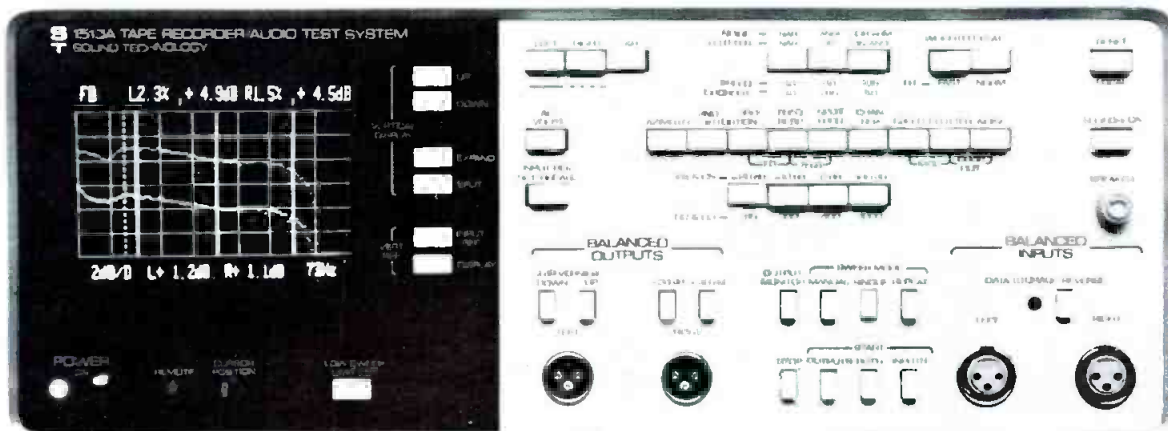

THE NEW 1510A

Call Sound Technology now. We'll show you how the 1510A can show you everything you ever needed to know and more... at a price you can afford.

I WOULD LIKE TO KNOW MORE ABOUT THE NEW 1510A

NAME	COMPANY	
ADDRESS	STATE	ZIP
PHONE ()		

ST SOUND TECHNOLOGY
Leaders in test and measurement for over a decade.

1400 DELL AVENUE
 CAMPBELL, CALIFORNIA 95008
 Telephone: (408) 378-6540
 Telex: 357445

Time Code and Mr. Edison

*So you think The Jazz Singer was the first sound film?
Well, think again.*

NOW THAT TV and the movies have re-discovered "good sound," synchronizers have become the pivot on which the audio-video production link hinges. But no matter who makes them, they seem to be replete with Murphy factors and Achilles heels. A few hi-tech buzz words will help mollify frustrated producers and studio managers with impressive sounding explanations for these malfunctions. These include: "errant bits"; "missing bits"; "invalid code"; and "poor retrieval."

If you have ever had to justify a ruined editing session or useless master, it might be a consolation that this has been going on for much longer than you'd probably guess. It predates SMPTE time code, television, and even *The Jazz Singer*. For before all of these there was Thomas A. Edison's "Kinetophone."

Most video and film productions strive to reproduce picture and sound in synchronism. Typically, the playback of audio and video is from a single medium. This is convenient, because if someone has finally succeeded in getting the sound and picture together in the first place, then there's a good chance that they'll stay that way when played back! However, for many production considerations, it's rare that the picture and sound are secured simultaneously. They are usually recorded on different, incompatible media which somehow have to interlock to one another. Once this is done, they can then be copied onto the final, composite form.

Well, there was once a time when there was no such composite format available. This meant that anyone trying to coordinate recorded sound and picture had to simultaneously operate and regulate two different, hopefully interlocked media. The problems and frustrations of this challenge delayed the introduction of practical sound motion pictures for years after the paying public and people in the film business seemed to be willing to embrace them.

Forget about the usual documentaries and public relations releases which concern the development of talking pictures. I'm tired of hearing that *The Jazz Singer* was the first sound film. There were several "films-with-sound" that pre-dated it. However, it *was* the first feature film in which electronically recorded and reproduced lip-sync was achieved. The sound came from 33-1/3 rpm direct-cut discs which were played on turntables which were geared to their corresponding projectors.

VITAPHONE

The success of *The Jazz Singer* in October, 1927 should not

have been a surprise to anyone in the film business. It starred Al Jolson, who at that time was a "hot property." It was based on a successful Broadway show which had starred George Jessel, who declined to play the film role because he thought it would flop. But it didn't, because it worked on breakthrough technology developed by Western Electric and its spinoff operation, The Bell Telephone Laboratories. The process was called "Vitaphone," a trademark now relegated to Warner Brothers cartoons.

Vitaphone's release had occurred more than one year before. It's first public use was in a documentary film shown at The AT&T Exhibit at The World's Fair in Philadelphia. In "The Birth Of The Telephone," Dr. Thomas Watson described his work with Alexander Graham Bell on developing the telephone fifty years before. Movie buffs might be interested to know that Henry Fonda neither looked nor sounded like the original! Then again, neither did Don Ameche...

Vitaphone's first theatrical release was on August 6, 1926. The debut program consisted of the silent feature "Don Juan," and lip-synchronous short subjects. The feature itself had post-scored M & E (music and sound effects) provided by a symphony orchestra. At that time, there were already technically successful sound-on-film systems available. These included Lee DeForest's "Phonofilm"; Theodore Case's "Movietone"; and even one by Western Electric/Bell Labs. All of them recorded variable-density tracks. For various reasons, Warners, the first licensee, deemed none as practical as a 16-inch slow-speed version of the ordinary phonograph record. Of course, a Vitaphone track couldn't be edited, but that was considered to be an acceptable trade-off at the time.

Although the idea of synchronizing discs to films was not new, Vitaphone benefitted from the latest advances in electronic recording and playback. Loudspeakers could now deliver sufficiently loud and clear sound to an audience, even in the gigantic auditoria of those days. Also, the recording and playback drives had synchronous and servo motors, so they were accurate. Vitaphone's predecessors were not so fortunate.

Prior to the advent of electronic recording (in which a microphone transduces sound vibrations into electricity), recording was done in several ways. All were replete with noise, distortion, and harmonic resonances. The most common was by sheer, brute mechanical force. A recording horn would collect sounds and concentrate them at its narrow end which was terminated with a diaphragm. A cutting stylus made lateral, vertical, or "compatible" grooves (which often weren't) which contained gross limitations. Playback was by an analogous but opposite method. The phonograph to which "Little Nipper" has been listening so attentively all these years operates on this principle.

Art Shifrin is Northeast Regional Sales Manager of Thomson-CSF.

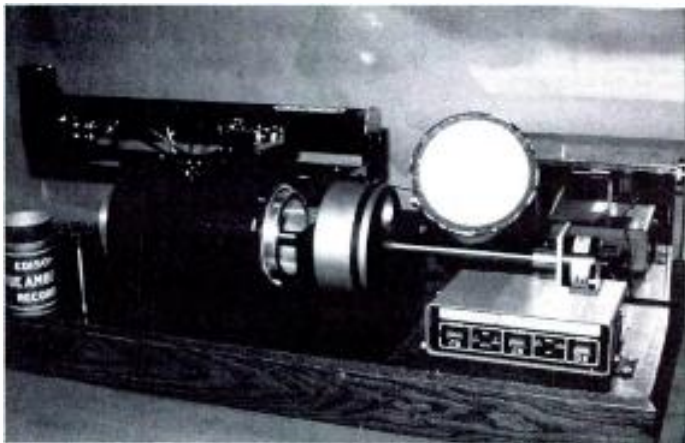

Figure 1. The author's electronic cylinder reproducing system, configured for Kinetophone playback. The tach is on the right end of the drive shaft, mounted on top of the preamp. A standard cylinder and its container are at the left, for size perspective.

OTHER EFFORTS

Even prior to Edison's development of the phonograph, other recording methods had been tried, if not perfected. In the late 1850s, Leon Scott de Martinville could record but not play back variable-area patterns on lampblack-treated paper. Bell and Tainter tried to record and playback variable-density ink tracks on glass discs in the 1880s. Poulsen recorded and played back magnetically on his "Telegraphone." Elias Reis had patents for magnetically recording on discs. Several inventors including Reis were able to record and play back on film. They included Ernst Ruhmer and Eugene Lauste. Their methods used string galvanometers driven by telephone transducers to modulate light patterns to photograph variable-density-and-area tracks. There was even a system called a "manometric flame." It used an acetylene flame modulated by magnetic fields generated by telephone repeaters. Density tracks could thus be recorded through an optical slit. Hopefully, nitrate film was not used in the latter! Selenium cells were used to play back these recordings without the benefits of electronic playback amplification. This was because DeForest had licensed his "Audion" (the first triode) to Western Electric for telephonic, and other uses. Even if other inventors had known about the "Audion" and could understand it, they could not have had access to the patents without a license from Western Electric. Its primary concern at the time was long-distance telephony.

Therefore, since phonograph grooves were the most reliable means of recording and playback, virtually all pre-Vitaphone talking pictures involved discs or cylinders. In 1921 D. W. Griffith produced and released the feature "Dream Street." It contained lip-synchronous scenes, including a prologue spoken by the director. The sound was on discs which ran at about 80 rpm. The recordings were cut and played back acoustically. The system was designed by one Orlando Kellum. Synchronization was evidently accurate, but the recordings were poor. The recording horns had to be located very close to the performers, so only tight shots could be made.

As early as the 1890s, Edison (or his staff) began working on combining motion pictures and the phonograph. At first, as with other inventors such as Oscar Messter, films would be shot to complement existing records, or vice-versa. Following the early phonograph marketing strategy, Edison released coin operated "talking kinetoscopes" prior to 1896. These were fifty-foot film loops, accompanied by wax cylinders heard through ear tubes.

The disc soon predominated the phonograph industry, and the Edison company was relegated to producing software for

systems it had sold. When they finally released "Diamond Discs" in 1913, these thick, vertically-cut records were superior to other conventional types. But they never achieved a significant market share because they were incompatible with most playback systems. Does this seem familiar? Even the Edison cylinders were meaningfully improved but their sales continued to dwindle. Edison ceased all recording and manufacturing in October 1929. Your guess is as good as mine if this had any causal, or symptomatic connection with the crash of the stock market during that month!

THE KINETOPHONE

Edison's cylinder enjoyed brief and little known glory as part of a synchronous "Kinetophone" sound film system shortly before World War I. It was the result of a collaboration between the Edison Company and an independent inventor, Daniel Higham. In February, 1908 Higham had proposed by letter that he be employed by Edison to "perfect" talking pictures. He held patents for a mechanical loudspeaking amplifier which could ostensibly generate sufficiently loud volume in typical theatres of that era. The system worked by generating friction between a rubber shoe and amber wheel which interconnected a playback stylus with a loudspeaking horn.

The system shown to the press in December, 1912 recorded cylinders and shot film simultaneously. It was also supposed to reproduce them in synchronism. Virtually everything seemed to conspire to cause Kinetophone's technical and business failures. These factors included: the basic design, a calamitous fire at Edison's West Orange complex, World War I, and the culinary tastes of rats which hung around Kinetophone equipment!

The fire destroyed the film building in December, 1914. It evidently consumed most of the documents, films, and recordings which pertained to Kinetophone. For many years, no one pursued the strategy of simply asking about any surviving Kinetophone materials at The Edison National Historic Site in West Orange, New Jersey. There I encountered Dr. Edward J. Pershey, The Site's Supervisory Curator. His enthusiastic reaction to my inquiries has resulted in uncovering significant amounts of information and artifacts.

The Kinetophone "soundtracks" were made on unusually large wax cylinders, 7½-in. long and 4¼-in. in diameter. Typical consumer cylinders were 4-in. long and 2-in. in diameter, and rotated at 120 rpm. The grooves were cut vertically at a pitch of 100 per inch. They were recorded acoustically from a horn which was generally placed further from the performers than was usual for recording sessions of that time. The wax masters were played on a pantograph equipped with a "Highamophonic" (my term to honor Mr. Higham) amplifier so that they produced copies which were louder than the originals. The copies were dusted with plumbago (finely pulverized graphite) so that they could be electroplated. The resulting tubular molds contained inverted grooves on their inside surfaces. The exteriors were reinforced with steel shells. Pre-cut tubes of celluloid would be steam pressed in these molds, so that the material would extrude into the metal grooves. Upon cooling, the celluloid records would shrink sufficiently so that they could be removed. The positive prints would then have plaster-of-paris cores formed within them. They were bored out so that their internal taper accommodated the mandrels on the "Kinetophonographs."

The recorders were evidently spring driven. Their drive shafts had pulleys through which a synchronizing belt was connected to a camera, which was evidently DC driven. The shooting recording would be preceded by the clapping of coconut shells. This was the slate used for negative cutting, and cueing for playback. The slate frames were replaced by black. Of course, the sync slap was retained at the head of each recording.

The playback system was even stranger. The reproducing phonograph was equipped with a second stage of Highamophonic amplification. It differed from the one used in the pantograph because instead of being connected to a cutting stylus, it drove a large reproducing horn. According to original

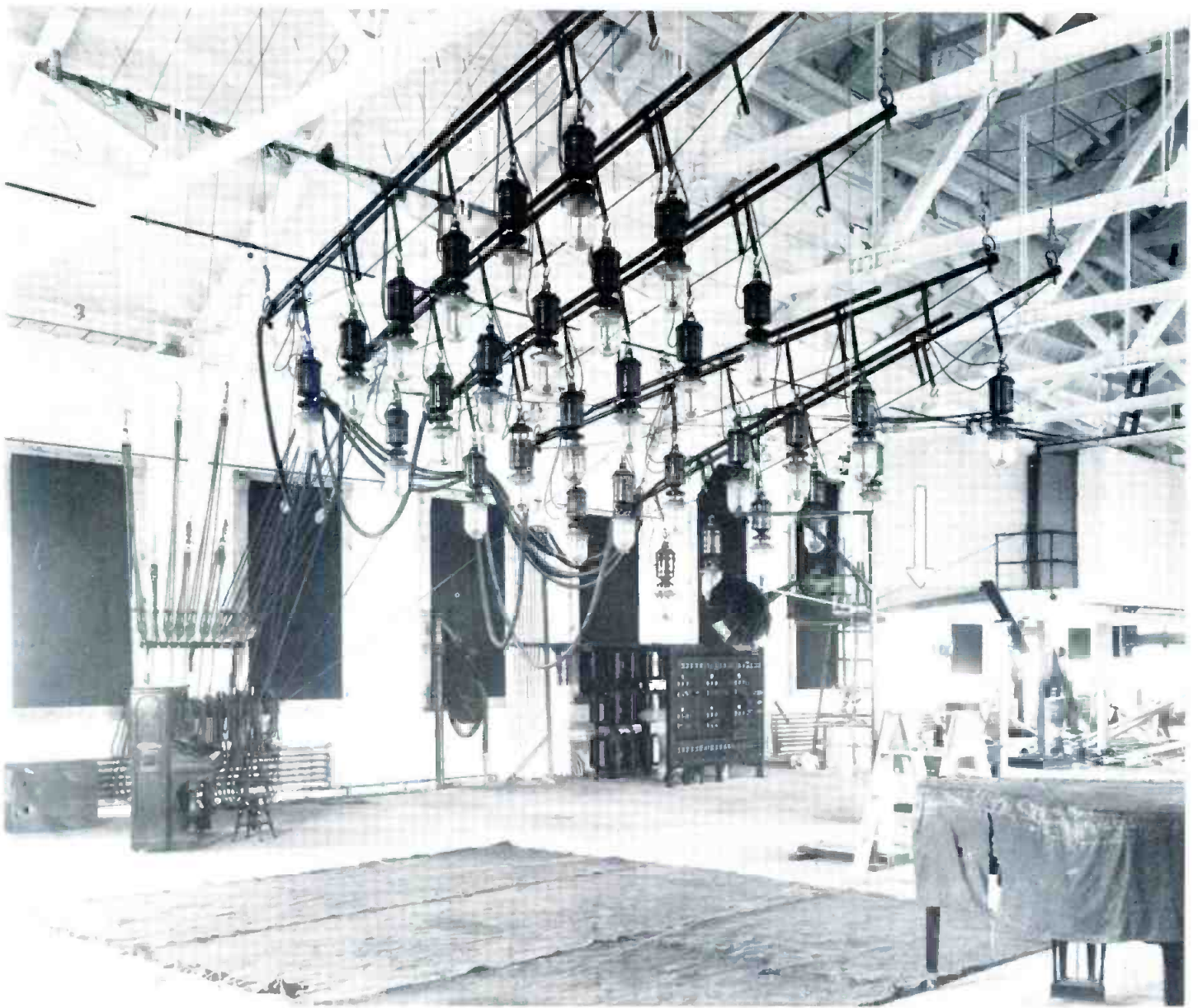

Figure 2. The Kinetophone Studio on Decatur Avenue in the Bronx. The arrow points to the synchronizing cord which leads to the left side of the recording phonograph.

notes. the total amplification was a magnitude of four times. The Kinetophonograph was driven by a 220-volt DC motor. (Edison is reputed not to have believed in AC.) Since perforated screens did not yet exist (except for holes made by missiles thrown by irate members of the audience), the unit had to be located in front of the movie screen. A synchronizer belt was guided by pulleys back into the projection booth. The projectionist had to hand-crank the film so that a mechanical indicator on a synchronizer driven by the belt sat at the correct position.

Of course, even when the indicator was right, the sync could be incorrect, so the projectionist had a manual override control. Seems familiar, doesn't it? A telephone system was supplied so that the projectionist could talk privately with the assistant operating the phonograph. They had to work with the precision of a modern football team. The record was cued to the middle of the sync slap. The motor was turned on with a clutch disengaged. When the second of black frames between the opening titles and first frame of picture appeared, the clutch was supposed to be released.

The *New York Times* of February 18, 1913 described the debut at Keith's Colonial Theatre in Manhattan the day before. The reviewer noted that "gasps of astonishment could be heard from the audience." but that "the only drawback was when the

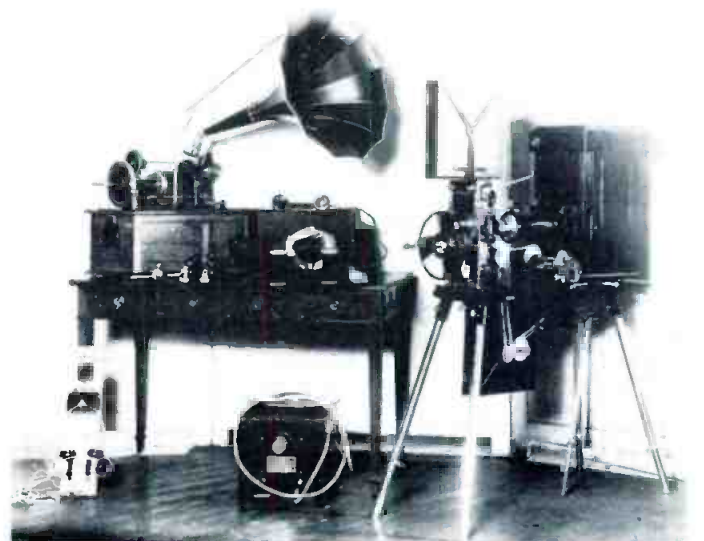

Figure 3. Except for the missing synchronizer cord, this is a complete Kinetophone reproducing system. The box on the floor is the power supply for the projector lamp. The telephones enabled the projectionist to talk with the phonograph operator.

db is the 1

Is your ad in the magazine with the largest circulation?

db is the 1

Is your ad in the magazine whose authors are the leaders in their field?

db is the 1

Is your ad reaching more of the decision makers in the broadcast and recording markets?

db is the 1

Is your ad being seen every month?

db is the 1

***Your ad can be in the
number 1 magazine—db***

For more information write or call us at:
1120 Old Country Rd, Plainview, N.Y. 11803 (516) 433-6530



Figure 4. Before finding the film and sound for The Edison Minstrels, the author incorrectly deduced that this was a meeting of the Kinetophone executive committee.

talk fell behind the picture." Edison blamed the sync slip on the equipment operators!

Knowing that most histories of The Cinema are virtually oblivious to Kinetophone, it could easily be guessed that the system was not extensively distributed. But papers found at The Site revealed plans for world-wide marketing. The deals covered the U.S., the United Kingdom, the Philippines, Russia, Austria-Hungary, Germany, Poland, Japan, India, and Scandinavia. Some of the contracts had war cancellation clauses.

A combined tally of the holdings at The Edison Site and at The Swedish Radio Company—where twenty-two Kinetophone cylinders were identified last year—total to forty different sound components and seven different reels of film. Of these, six subjects have corresponding sound and picture. Their contents support some of the memoranda found at The Site. They also reveal surprises. Photographs of the Kinetophone studio on Decatur Avenue in The Bronx readily explains the severe echoes heard in some of the recordings. The ceilings were high and the walls were wooden. One memo discussed the need for a new studio with canvas treatments to prevent this problem. The records contain varying types of echoes, so perhaps the existing studio had been modified, or a new one built.

At least two of the productions were featurettes. Cylinders for parts one and five of *The Deaf Mute*, a military drama by Rupert Hughes, survive at The Site. It's a play about a Confederate spy who masquerades as a peddler in a Union Army Camp. All of the action occurs in front of a tent whose flaps are tied open. The recording quality is amazingly clear and completely without echoes. Even the clucking of a chicken carried in the peddler's basket is clearly audible. Probably made in mid-1913, this could very well be the first on-location theatrical synchronous sound film! Cylinders for parts one, two, and four of another multi-reel production *Die Puppe* (The Puppet) are in the collection in Stockholm.

AN ELECTRONIC CYLINDER REPRODUCER

Since my interest in playing and dubbing cylinders preceded The Kinetophone Project, working out a system to play the tracks benefited from previous experimentation. I had begun to develop an electronic cylinder reproducer about three years ago. This was in response to a personal whim, which was later fired up by a request from The U.S. National Archives to dub Dictaphone cylinders made by The Department Of The Navy in the late 1930s. The system eventually evolved so that two could be sold and delivered. One went to The Rogers and Hammerstein Archives Of Recorded Sound at Lincoln Center. The other went to The Swedish Radio Company. Both have significant collections of cylinders. My trip to Stockholm in

August, 1981 to install the unit resulted in finding their twenty-two records. Claes N. Cnattingius, the Director of the Gramophone Department of *Sveriges Riksradio*, has also significantly contributed to my research about the Kinetophone.

The system I designed circumvents the playback problems inherent in acoustical reproducers. It does not have the speed fluctuations of the spring-driven motors. It avoids the liabilities of trying to mike a playback horn. The system accommodates the multiplicity of lengths, speeds, diameters, and groove pitches of the various kinds of cylinders which were made. It even tracks them at half speed, so that severely warped records can be played without pickups bottoming to the cylinders' surfaces. It was therefore rather easy to further modify the system so that the Kinetophone records could be played. These changes included fabricating an appropriate mandrel, and adding a tach generator to the drive shaft. A 60 Hz control signal is thus generated and accounts for any phase shift from the drive motor, belt, and pulley. The control frequency is recorded separately on the master tape. It is ultimately used to resolve the tape to a perforated magnetic recording film, or time-coded submaster.

The audio is processed with some unusual techniques. First, styli made to my specifications by Stanton Magnetics and Expert Pickups Ltd. track the records. The pickups are Stanton 500 whose two outputs are oppositely phased. The two outputs of the Stanton 310 preamp are mixed so that a maximal noise null of the non-vertical noise is obtained. These settings are often not at unity gain, since the grooves were often not cut on truly vertical planes. The audio is taped with linear phono preamplification, using no compensation. It is ultimately processed through a variety of equalizers, transient noise suppressors, compressor/limiters, and filters. Most of the Kinetophone cylinders from The Site are so warped that half-speed transferring was necessary.

The films had to be transferred to videotape so that they could be readily reproduced and hopefully, synchronized. At the time that this phase of the experiments was being undertaken, I enjoyed a very special relationship with The Sound Shop and Reeves Teletape divisions of Reeves Communications. I had done free-lance production work there and my clients, Thames Television, had been very pleased with the results. Knowing much about the Reeves operation and extensive technical experience with film, I decided that this unusual work should be done at their East 44 Street studios in Manhattan. Sound Shop Vice President Walter Willumstad was instrumental in coordinating the challenging sessions which followed.

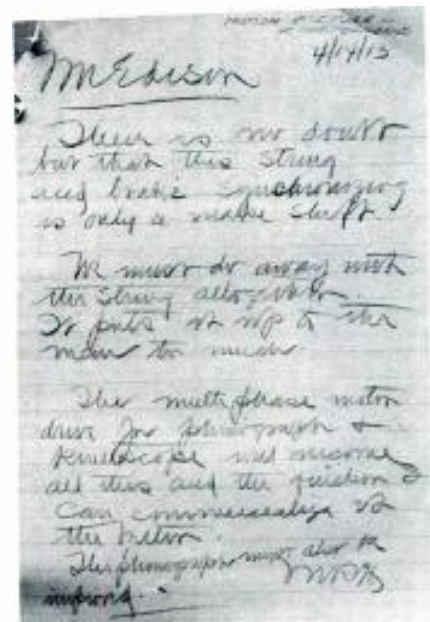
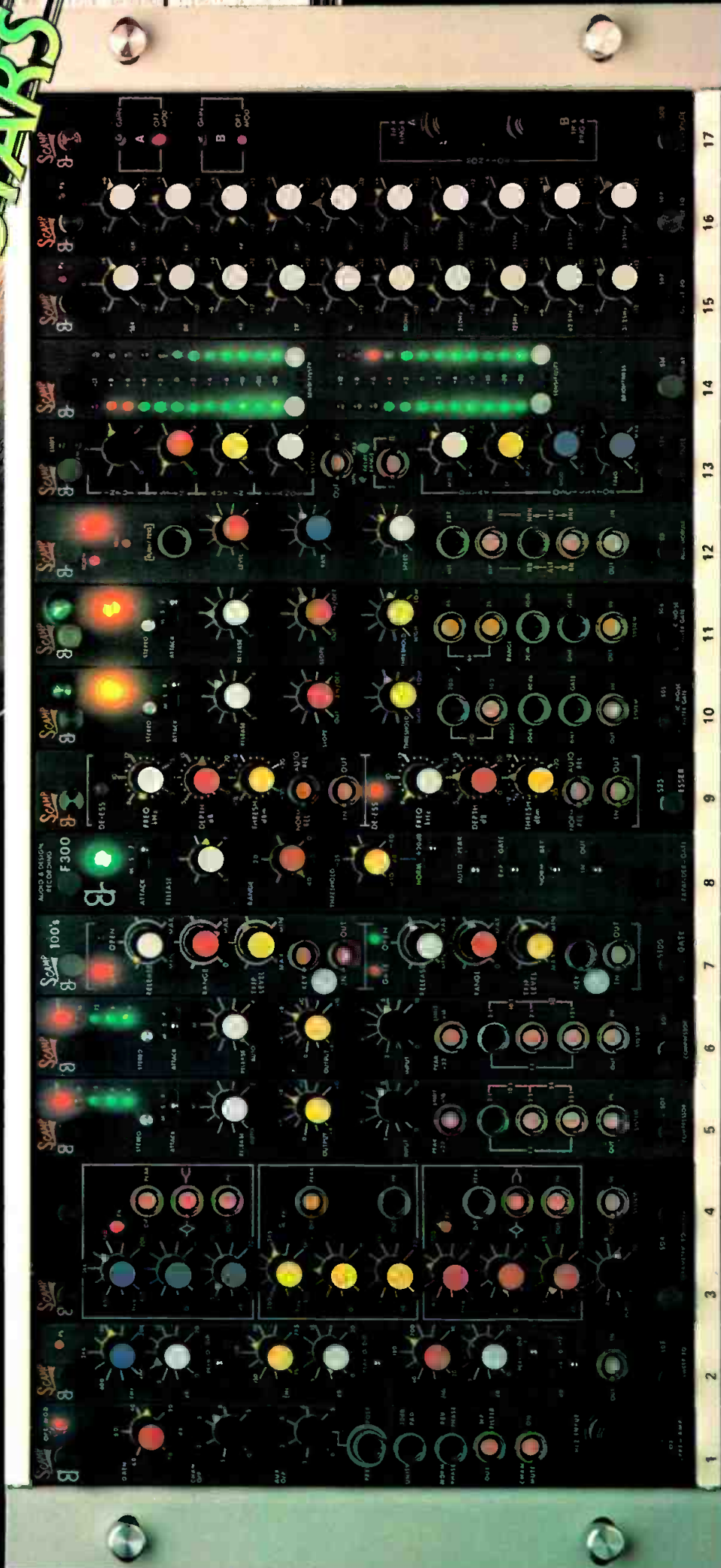

Figure 5. Miller Reese Hutchinson's memo to Edison about the synchronizer problems.

GIZMOS OF THE STARS

EXQUISITE PERFORMANCE AND SUPERIOR TECHNOLOGY HAVE MADE SCAMP[®] THE WORLD'S MOST CREATIVE AND VERSATILE SIGNAL PROCESSING SYSTEM. THAT'S WHY MORE HIT-MAKING ENGINEERS, PRODUCERS AND MUSICIANS DEMAND SCAMP OVER CHEAPER ALTERNATIVES. IN TODAY'S COMPETITIVE RECORDING BUSINESS EVERY WORLD CLASS STUDIO OFFERS THE SCAMP ADVANTAGE. CALL TOLL-FREE 800-426-6170 FOR MORE SPECS AND INFORMATION.



- 17 CLEAN DISTRIBUTION IS YOURS WITH THE 2 IN / 8 OUT S08 DA MODULE.
- 16 OPTIMIZE YOUR MONITOR SPEAKERS. THE COMPACT S07 OCTAVE EQUALIZER IS CLEAN AND COST EFFECTIVE.
- 14 FAST RESPONSE AND EASY TO READ: THE S14 LED QUAD METER (PPM OR VU).
- 13 DYNAMITE ADT AND FLANGING EFFECTS FROM A S24 TIME SHAPE MODULE.
- 12 STEREO PANNING. AUTOMATICALLY! THE S23 PAN EFFECTS MODULE.
- 11 ELIMINATE HISS WITH THE S06 DYNAMIC FILTER / GATE MODULE.
- 10 REMOVE LF NOISE WITH THE S05 DYNAMIC FILTER / GATE MODULE.
- 9 SCAMP'S LATEST: S25 DUAL DE-ESSER FOR SUPERLATIVE SIBILANCE CONTROL.
- 8 MUTE NOISE AND TIGHTEN TRACKS WITH THE F300 EXPANDER / GATE.
- 7 THE GREAT GATES - THERE ARE TWO IN EACH S100 DUAL GATE MODULE.
- 6 CONTROL DYNAMIC RANGE WITH THE S01 COMPRESSOR / LIMITER. FEATURES "SOFT KNEE" SLOPES AND PUSHBUTTON STEREO COUPLING.
- 5 THE ULTIMATE EQUALIZER! THE S04 PARAMETRIC WILL SOLVE YOUR MOST COMPLEX EQ PROBLEMS.
- 4 THE VERSATILE S03 SWEEP EQUALIZER IS EASY TO USE.
- 3 TRANSFORMERLESS S02 MIC PREAMP WILL INTERFACE WITH LOW LEVELS.

NOT SHOWN:
6 MODULE MINI RACK.
SCAMP POWER SUPPLY.
EXTENDER BOARD.
SCAMP BLANK
MODULE KITS.
(AVAILABLE IN 1 TO 8
MODULE WIDTHS.)

Audio+Design



CALL TOLL-FREE 800-426-6170
AUDIO & DESIGN RECORDING, INC. - P.O. BOX 786 - BREMERTON, WASHINGTON USA 98310 - TELEPHONE 206-275-5009 - TELEX 15-2426
AUDIO & DESIGN RECORDING, LTD. - NORTH STREET, READING RG1 4DA BERKSHIRE, ENGLAND - TELEPHONE (0734) 53411 - UK TELEX 848722
Copyright 1981 by Audio & Design Recording, Inc.

Circle 31 on Reader Service Card

Fortunately, none of the Kinetophone reels are original nitrates. If they were, they'd probably be brown gelatinous blobs by now. They're all safety-base 16 mm and 35 mm copies with various problems. One is a fine-grain master dupe and notwithstanding jitter, has startling clarity for a sixty-nine year old film. New prints were made by Karl Malkames, who specializes in contending with old, distressed motion picture film.

Back timing the pictures to the sound indicated that the films should run at approximately 16 frames per second. The engineering budget did not permit the time to modify the RCA FR 16 telecine to servo to any non-standard speed, so we decided to make the master transfer at the standard 24 fps. Senior Supervising Colorist Gerry Keller achieved significant improvement in the pictures' qualities.

The color corrected one inch type "C" video tape masters were then dubbed in a vari-speed mode to the equivalent of 16 fps. This was done by controlling an Ampex VPR-2B with a Lexicon 1200 Time Compressor. The 1200 is well known for its remarkable ability to change an audio track's speed, while retaining its original pitch. In this application, it was used as a precise, programmable external reference oscillator for the VPR's capstan servo. It enabled us to exactly program the required *video* speed. This had to be done in two steps, because the 1200's limit of speed change is 25 percent, and we required a one-third speed reduction.

Some blurring of movement became noticeable at the conclusion of this procedure. There are several explanations for this. One is that when film is transferred to NTSC (the U.S. Standard) video, some fields (two fields comprise one video frame) are selectively duplicated. This is done because it is necessary to stretch the 24 film frames of one second, to the television scanning rate of 30 fps. Also, the pick-up tubes in even the best video film cameras (in this case, an RCA TK 29) introduce an image lag. This occurs because it takes the tubes (one each for the green, red, and blue channels) a certain amount of time to "forget" a previous image. Both of these factors become exaggerated when tape playback is significantly slowed down. Finally, the films generate less smooth "persistence of vision" because having been shot at 16 fps, their frames were each exposed 50 percent longer than those shot at today's standard speed of 24. The results however, are blatantly better than the traditional, primitive methods of either running films of their vintage too fast, or "stretch printing" them. The latter method entails duplicating alternate frames so that the elapsed running time is correct. Because of the duplicated frames, the "persistence of vision" disintegrates and the motion becomes stroboscopic. If these Kinetophone films had been processed in either of these two ways (as silent films often regrettably are), then the sound could not have been

cal horn, "stretch printing," and picture editing. The results were even then, unnecessarily bad since vertical electrical phono pickups were available at that time. I was determined that these new efforts would circumvent such degradations, and do justice to the aspirations of Edison, Higham and Hutchinson.

Once the speed corrected video master was completed, we tried to match the sound to the picture. Two easily identifiable sync points were selected near the beginning and end of the first subject. These occur when a speaker strikes a table with a gavel, and when someone drops a whiskey bottle. Both are seen and heard. With the video matched to the audio at the first sync point, they were run interlocked. The sync held rather steadily: the sound was behind the picture by only 20 video frames after five minutes! We were disappointed but not surprised at the imperfect sync. Yet, considering the original method of production, this degree of accuracy we realized, was a pleasant surprise. Jerry Neumann, the Editor with whom I was working,

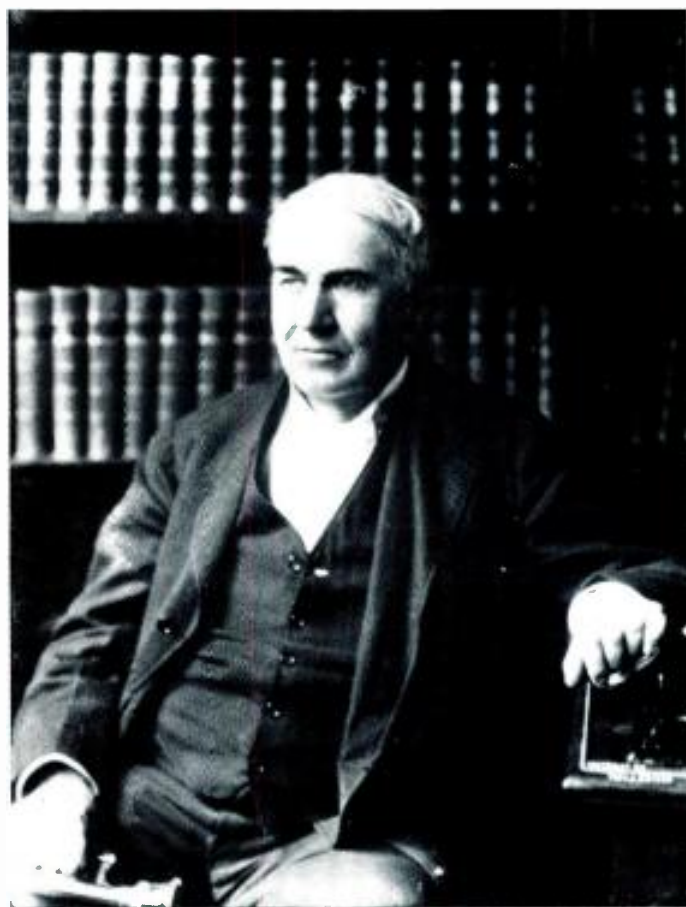

Figure 7. Thomas A. Edison, about the time of the Kinetophone project.

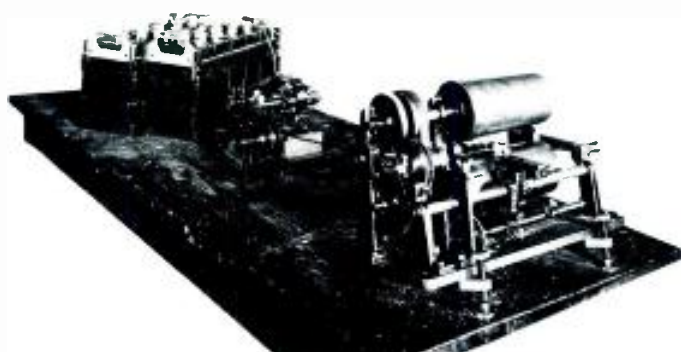

Figure 6. The Kinetophone amplifying pantograph. The master was played on the upper mandrel with the pickup at "6 O'Clock." Notice the wax cuttings all over the assembly.

helped to conceptualize the procedure by which we finally corrected the sync. We'd partially emulate the original Kinetophone projection concept by further modifying the speed of the video. The picture was once again dubbed so that it would be .1 percent (one tenth of one percent) shorter than the audio. This is the smallest mathematical factor of speed change which can be programmed into the Lexicon 1200. The audio was again cued to the first sync point and run interlocked to the picture. When the sync began to slip, the audio was pulled up by editing out brief, unmodulated sections of the soundtrack. This way, no recorded sounds or frames of film were cut out. *The Five Bachelors*, a humorous account of an initiation into a men's club, was thus synchronized. Only five pullups had to be done, each only about one sixth of a second long and completely undetectable. This could very well be the earliest surviving synchronous sound film, because papers at The Site indicate that it was produced in late 1912!

The second experiment was much more difficult to do, because most of it drifted so quickly that phrase-by-phrase correction was necessary. The same technique was applied, and the results are particularly gratifying. This is because the subject

was Reel One of *The Deaf Mute*, the precocious five reel, on-location production.

The sync drifts which we encountered bore out the complaining memos found at The Site. Apparently, the

from these masters new less noisy and non-warped positives could be injection molded. Funding, and perhaps even an institutional affiliation are necessary so that this, and other planned work can be continued and done properly.

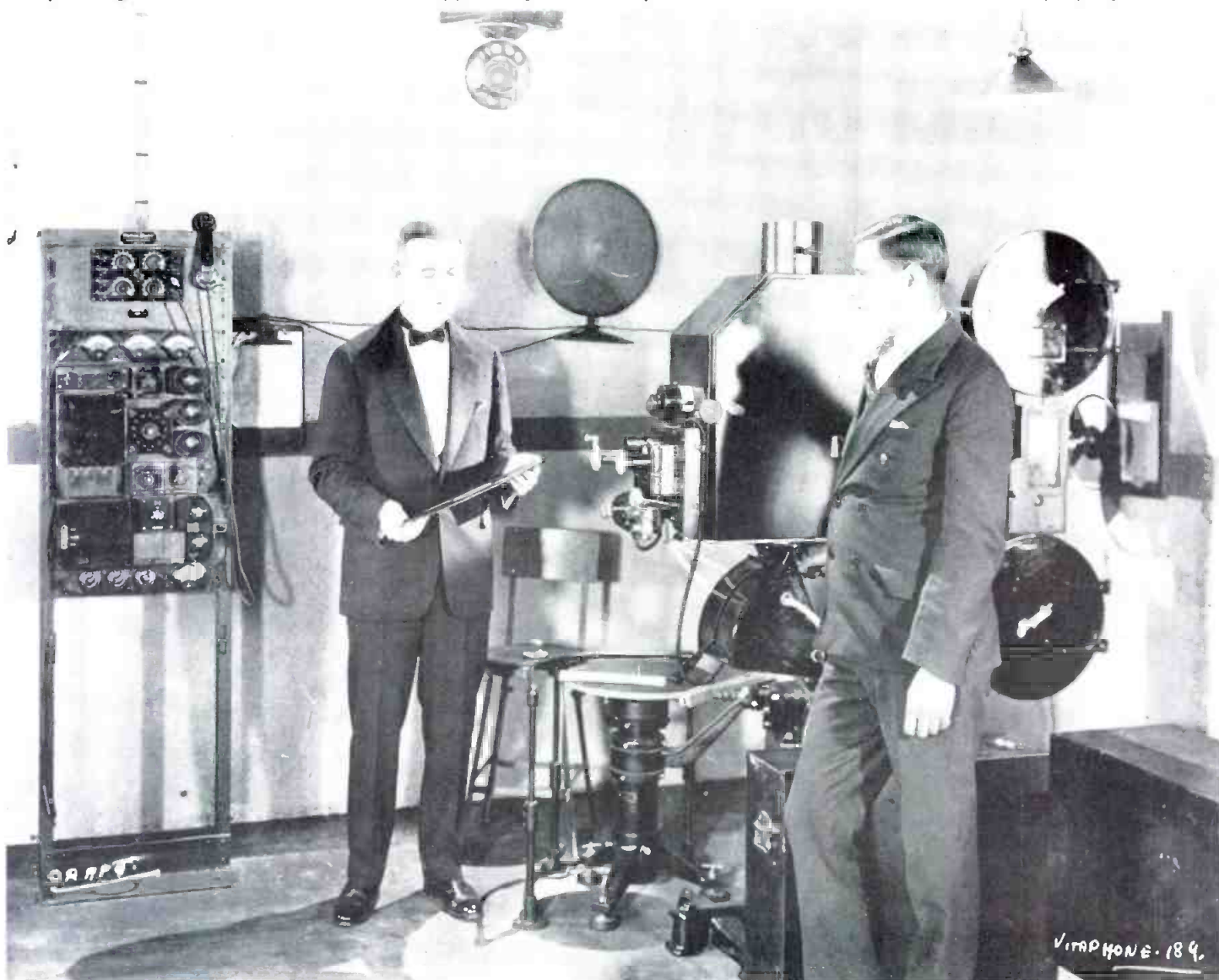

Figure 8. A Vitaphone set up showing the projector, turntable, and amplifier. Edward B. Craft, vice-president of Bell Telephone Labs, is holding the soundtrack record. This is a still from *The Voice of the Screen*, a four reel explanatory production presented at the New York Electrical Society in October, 1926.

synchronizer between the camera and recorder never worked properly. Only if they had built a direct, mechanically interlocked playback system could they have recognized the differences between those problems which arose during production, and those which occurred during projection. This was evidently not done. But they did try to address the problem with a more sophisticated method of synchronization. By April 1913, about midway in the four month engagement of the Kinetophone program at The Colonial, the Chief Engineer of the Kinetophone project, Miller Reese Hutchinson, was working on an electrical synthesizer which made too much environmental noise. We have not yet found any description or schematics, and don't even know if it was ever used theatrically. However, memos and photographs indicate that at least one was built and being evaluated. At least one other contemporary factor is probably also causing some of the sync problems. Most of the cylinders are so warped, that even when turned at a constant speed, their surface velocities necessarily change continually.

At this writing, two of the films have been transferred to videotape. These, and the remaining reels have severe picture problems whose correction would be very expensive. More research and development is necessary. The search for other surviving materials must be continued. Metal molds for some of the Kinetophone records survive at The Site. Theoretically,



Figure 9. A non-synchronous soundtrack disc pressed by G & T for Oscar Messter's *Biophon*, circa 1906. Photograph courtesy of Ray Wile.

Oh yes, what about the rats? When you're next talking to your friendly tech-support person from your favorite synchronizer company, think about a memo from Mr. Hutchinson to Mr. Edison and try to top it: the rats liked to eat the synchronizer cords! ■

The Wonderful Sound World of Walt Disney

From Burbank to Los Angeles, our roving reporter searched for the inside story on the soundtracks of the Disney films "Fantasia" and "Tron."

I AM HERE in beautiful downtown Burbank, wherever that is, to pick up the evolutionary threads of the Disney film *Fantasia* (or Music Appreciation 101, as we used to call it). I will do this by visiting and asking intelligent questions of the Disney studios, wherever they are. The only likely site is plainly a gravel quarry, walled in by a motley array of barriers to keep offensive sights and sounds from the surrounding neighborhood. I chance it anyway, and predictably encounter rocks—plastic rocks that I seem to remember from a particularly stirring moment of *The Swiss Family Robinson*. It's the right place, but the wrong entrance.

At the right entrance I ask whether all this deliberate anonymity is an attempt to foil the attentions of the curious and crazy. The reply is a guarded "Yes, that's probably the idea." The guardedness strikes me immediately. The question was evidently not phrased in accordance with the Disney world view, which exalts (but not forcefully) good will, tolerance, the decent side of life, and the child that continues to live within the man. Still, I fleetingly recall that the satanic monster from *Fantasia*'s "Night on Bald Mountain" sequence gave my little sister nightmares for weeks. But that is hardly fair. It didn't bother me; I even bought the record.

FANTASIA ET AL

What strikes me shortly after is the faintest tinge of something like quiet desperation. The place is clearly given over to hard work, accounts of all kinds are strictly kept, and reprimands are probably not hard to come by. I suspect you toe the line if you want to participate in Disney's activities, but what does this monastic devotion lead to? By critical consent, no film

has emerged from the studios since Walt's death that has not been forgettable. *Fantasia*, now over forty years old, probably remains at least as novel and audacious as any original release the studio will put forth this year. And audacious it was, daring to be a dialogue-less movie, daring to flaunt well over an hour of "artsy" music in the face of the matinee crowd, daring to go farther than anyone had in sound production and reproduction, and, yes, daring to scare the living daylight out of my sister to make its point—a most un-Disneylike trait in recent years.

In my conversations with sound production and support people, I find no one who was in any way close to the original *Fantasia* of 1938. So we're left with just the knowledge in general circulation: that it grew from a short subject (*The Sorcerer's Apprentice*) into a full-length feature; that sound recording commenced with a pick-up orchestra in Hollywood, but was largely carried out with Stokowski's Philadelphia Orchestra in the Academy of Music; that the recording was (incredibly!) done optically on eight tracks (nine if you include a click track used by the Disney artists in preparing the picture), and that the picture was shown whenever possible with a four-track optical format spanning the entire width of a separate 35-mm film that required its own "semi" projector and special sound head for reproduction. Three tracks were audio for left, center and right behind-screen speakers. The fourth carried multiple control tones that gain-rode the feeds to multiple theatre loudspeakers in such a way as to introduce sound-source shifts as desired, and to maintain S/N with a reasonable dynamic range. To switch on and off surround speakers, the sound-track film was notched.

Fantasia is often called the first stereophonic motion picture, but it wasn't really. It was pan-potted multi-track (there being no pan pots in the film industry at the time, Disney had to design one and have it built), and was probably mono as often as not. Certainly during recording the greatest attempts were

Ralph Hodges is a freelance writer/editor working out of the San Francisco bay area.

made to acoustically isolate each orchestral choir and its microphone from its brethren, a then-unfamiliar arrangement that reportedly caused much trouble with ensemble.

THE NEW FANTASIA

Informants in the film industry tell me the Disney people were urged from several quarters to redo the *Fantasia* sound track while Stokowski was still able to conduct. The track, long since transferred to four-track magnetic striping for its more elaborate presentations, was still 1938 optical in origin and a technical embarrassment. But the Stokowski connection was never made, and so, about a year ago, noted Hollywood conductor and arranger Irwin Kostal took a pick-up band onto the CBS Studio Center scoring stage (Disney has no facility big enough) to finally get the music re-recorded. He also brought with him some new arrangements, so that musical-conscious theatregoers who were once jarred by Stokowski's liberties with this hallowed repertoire are being jarred again.

If *Fantasia* was perhaps the only successful major film to be set to music, rather than the other way around, it has now come full circle. In 1938 Stokowski set the beat (often an eccentric one) and the Disney animators followed. Things were reversed for the Kostal sessions. Here the picture, incorporating Stokowski's rhythms, was inviolate, and the music had to be made to fit. The Disney folk advise that Kostal had the usual on-screen images and click track to guide him, but also relied heavily on a headphone feed of the Stokowski original, apparently hoping that hearing the full shape of the music would make comprehensible the rhythmic variations.

From what I can tell, the sessions themselves were unremarkable orchestral multi-track efforts—except for being recorded, edited and ultimately mixed in PCM (the 3M system was used). Disney once had hopes of staying in digital all the way into the theatre but the necessary theatre equipment simply could not be arranged for in time. How about, then, a 70-mm release with six-track Dolby stereo (I am told, rather wistfully, that there was even hope of using stereo surrounds as in *Apocalypse Now*)? This would at least get the left and right front speakers out from behind the masking curtains used to close off those portions of the screen not occupied by the smaller (because grainier) 35-mm picture. But the budget was not there for 70-mm release prints. So *Fantasia* is returning to showcase theatres in 35-mm four-track magnetic once again. Can't fault the Disney sound guys for not trying, though.

Last stop on the Disney lot is the dubbing theatre, presently in use to screen and audition, in real time, every single reel of every single *Fantasia* magnetic release print to be sent out. The chap in there, who rotates shifts with two others, seems a little walled. I expect he dreams about *Fantasia* at nights. I hope he doesn't have my sister's nightmares.

W. E. GARITY ET AL
SOUND REPRODUCING SYSTEM
Filed July 31, 1940

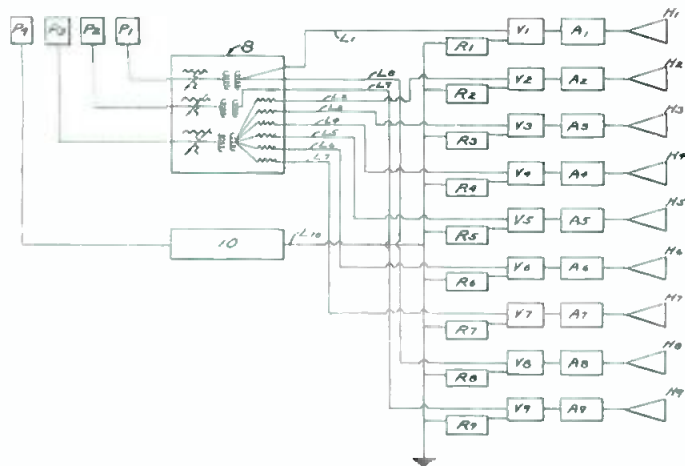

Figure 1. Disney technicians proposed—and patented—this configuration of electronics for reproducing "Fantasia" in showcase theatres. Like the loudspeaker array of Figure 2, it was probably never realized in all its glory.

MAGNECORD MC-II

Compare Quality at this Price



Incomparable
from \$1100.00*

- Meets or exceeds NAB standards, with IEC equalization on request.
- DC servo, flutter-filter drive runs true regardless of line voltage fluctuation.
- Cool operation; no ventilation required.
- Full remote capability.
- Long life heads and phase locked tape guides.
- Mono or stereo play models field convertible to record.
- Automation cue tones (stop, secondary, tertiary) with LED's and external switching contacts.
- Cue track access for FSK logging.
- Universal mic/line input.
- Immune to RFI and EMI.
- Rugged design in the MagneCORD tradition—made in USA.

*Suggested Pro Net Price

Quality Products for the Audio Professional

TELEX MAGNECORD

TELEX COMMUNICATIONS, INC.

9600 Aldrich Ave So Minneapolis MN 55420 U.S.A.
Europe Le Bonaparte Office 711 Centre Affaires Paris Nord 93153 Le Blanc Mesnil France

Circle 49 on Reader Service Card

ON TO TRON

I am here (via telephone) in beautiful semi-urban Los Angeles, wherever that is, to find out what I can about the sonic collage that became the soundtrack for *Tron*, Disney's latest release and a somewhat incoherent epic securely grounded in electronic faddism and the enduring values of truth, justice and the good, solid buck. Knowing that Frank Serafine (Serafine FX), who made all the picture's noises, did not also write its screenplay, I am inclined to give him every benefit of the doubt. He rewards my positive attitude with revelation heaped upon revelation, until I am reeling.

Serafine, who has himself discussed his techniques for "Electronic Sound Assembly" in these pages (May 1981), notes that if *Fantasia* was the first soundtrack to pass through production and post production in digital form, *Tron's* sound was virtually a comparable first for multi-track tape. His top-of-the-head estimate is that Disney probably saved \$25,000 in 35-mm magnetic-film transfers as a result, cut down on scads of post-production time, and got freshly minted live ("organic") and synthesized sounds as a bonus.

Instead of the sprocket holes and picture frames of film, Serafine's operation runs on SMPTE time code linking the sound on audio tape and the picture on video tape. The same code, recorded on all effects tapes in his 1/4-inch library, marks the locations of sounds for ready retrieval. The library's "card catalog" consists of computer files indexed for such categories as the sound itself, where and when recorded, reel number, track number, clock number, generic type of sound, visual correlate of the sound, and so on. Punching in a particular category sifts through the files and displays the applicable entries. The reel number takes you right to the desired 1/4-inch reel, and time code to the desired spot on the reel.

There's nothing here to take your breath away until you contrast it with the usual Hollywood procedure as described by Serafine. "I know of enormous effects libraries that spend one third of their time just locating the sound called for amongst all the reels of 1/4-inch tape. When they find it, they put in a little piece of paper tape to mark it, and then the transfer guy gets

2,298,618 Oct. 13, 1942.

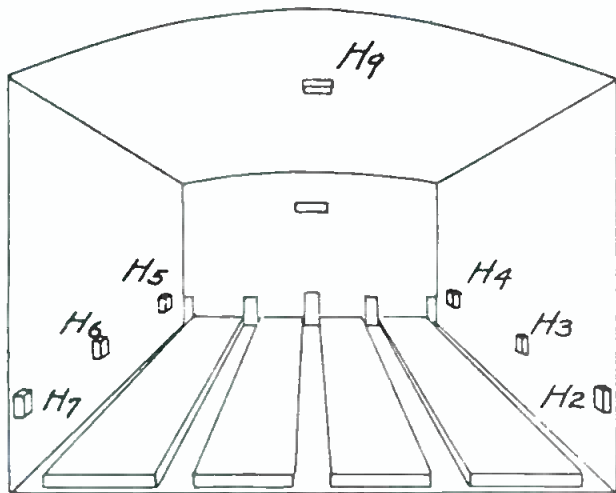

*WILLIAM E. GARITY
JOHN N.A. HAWKINS*
INVENTORS

BY *C. J. Mitchell*

ATTORNEY.

Figure 2. Proposed arrangements of theatre loudspeakers for fullest impact of "Fantasia." Drawings from patent #2,298,618.

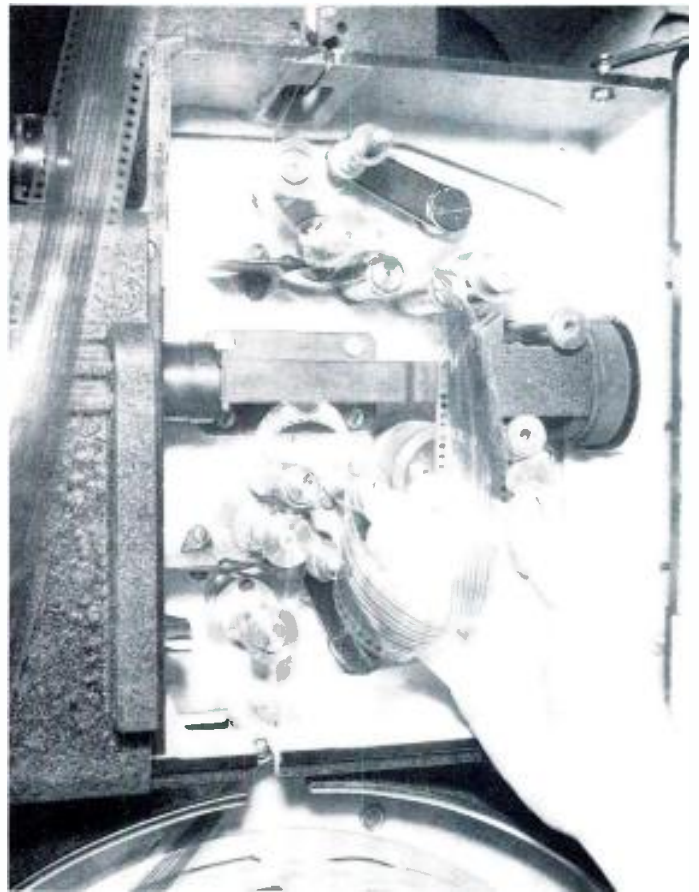

Figure 3. The amazing "Fantasia" optical soundtrack, with the sound head designed to play it.

it to put it on 35 mag. Maybe a day or two later you get your copy. You line it up with the other elements on your bench, which can handle only three units at a time, with the result that you hear only three elements at a time out of maybe fifty that will go into the final mix. It's archaic."

With his Tascam 85-16, Serafine can hear up to fifteen elements at a time (track 16 carries the ubiquitous time code) at his pleasure, once the elements are dubbed from 1/4-inch. On their way through the transfer, the elements routinely encountered analog, digital and computerized signal processing, various forms of delay, reverb, phasing and flanging, and (a great favorite especially for dialogue) the EXR Exciter III. For example, each of the three motorcycles had three tracks solely dedicated to it, for a total of nine tracks. Two of the three were used to "split off and do reverb and perspective-type things with." The remaining six tracks might accommodate great changes in picture perspective, other thoughts on how to add dimension to synthesizer sound ("The hardest thing," says Serafine), and other effects (crashes, explosions), perhaps with some actual stereo present or injected if Serafine thought the effect unquestionably benefitted from it.

As for the content of the elements: "We built up the basic cycle sound using the Prophet 5 and Moog synthesizers, layering on related elements as called for to respect the perspective of the picture. But all the fly-bys were real motorcycles (Sunday-afternoon drag racers I miked with crossed Electro-Voice RE20s and a Stellavox SP-8), later processed through a Delta-Lab Acousticcomputer to give them that synthesized quality. Dopplers are very hard to create on synthesizers, so I thought it better to take the skeleton tracks of real motorcycles and process them."

LOCATION PRODUCTION OF EFFECTS

There are very few effects in *Tron* that didn't come from Serafine's studios and rapidly growing library, or from field forays to find the right sound, be it the airbrakes of an LA bus or the laboring engines of the Goodyear blimp. The convenience of working with video tape offered some shortcuts.



Figure 4. Pan pot circa 1938, promoting togetherness in the Disney manner.

"For the van pulling up to break into the labs (not the van you see in the picture, but the one recorded for the soundtrack), we set up a large video monitor in constant view of the driver, put up the actual scene from the film, and let him keep pace with it through the braking of the vehicle, the opening and closing of the door, and so on. For the Goodyear blimp (miked from inside and outside the gondola, and from the ground, to create "base" sounds for the oversized hovercraft thing in the final reels) we brought along a smaller monitor and a Technicolor VCR, let the navigator see what we were up to, and had him fly around in sync with the screen action. It's real-life Foley, and can work just as well as anything done on a sound stage with props, saving considerable post-production time to boot."

After being logged in on the computer, tapes from the field judged immediately usable for *Tron* were transferred to the Tascam 16-track before joining the other reels in the 1/4-inch library. Tapes requiring mechanical editing received same, at first, to preserve first-generation quality. "But in the time crunch at the end, I found I could dump effects into the storage of the Fairlight CMI, manipulate them in real time, and often bring them into sync faster than if I were trying to program an edit. I could also play material backwards with ease, doing such things as turning high-impact sounds into suction sounds."

THE BIG MIX

Before going to the dubbing theatre in the Lion's Gate studio complex upstairs, *Tron*'s assembled elements were transferred again, to an Ampex 1-inch 16-track (matching the Lion's Gate machine) that was slaved to the 1/4-inch video tape of the picture.



Figure 5. Then as now, the Stokowski seen on the screen was not conducting for the orchestra, but for the camera.

For some scenes there were as many as four units (16-track reels), plus additional effects elements that were often already waiting on 35-mm magnetic film up above. Mike Hinkler, the principal dubbing engineer, could not be sure just how many separate but simultaneous elements were being handled at any one bad moment. Sixty or so seems a conservative guess. But in any case, this was when Serafine's multi-track tapes at last became mag films for the final mix.

The mix, although employing Dolby noise reduction throughout, was something of a throwback to pre-Dolby times, when all six magnetic tracks of a 70-mm release print were at full-range, driving five behind-screen speakers with discrete information. (The Dolby scheme for 6-track is full-range for only three behind-screen speakers, relegating the two others to low-frequency reinforcement or "boom." In both schemes the sixth track is dedicated to auditorium "surround" speakers.) I wonder why this format was chosen, but the decision seems to have been a popular one, expected to lead to more dramatic on- and off-screen localization effects. Says Serafine: "Traditionally, you don't create sound effects that turn the audience's head. You keep attention focused on the screen. But I wanted to break that rule."



Figure 6. Frank Serafine at work in his studio, creating the sounds used in the Disney motion picture "Tron."

TRON II?

Serafine mentions that he is presently acquiring a small arsenal of digital recording equipment, including the Sony PCM-F1, ostensibly a consumer product. "Yeah, but it's so good, and it's an ideal location machine." The idea is that the video tracks of the associated VCR will take the audio, while the audio tracks will handle that of SMPTE time code. Frank also talks briefly about using something like the PCM-F1 as the master recorder for his whole operation, making it seem like he plans to carry his elements, two at a time, up to Lion's Gate for transfer to 35-mm dummies. Well, why not? And in any case, the PCM-F1 *should* be an ideal location recorder, and no waste of money.

There is also some talk about LaserDiscs as permanent immediate-access effects libraries. Frank mentions that Lion's Gate intends to acquire a bank of about fifteen players, to render such hypothetical libraries suitable for dubbing-theatre work. The idea seems most attractive, but neither of us can decide where the discs themselves might come from at this time.

The real irony, I suppose, is that Frank Serafine, having taken motion-picture sound production about as close to multi-track tape techniques as it's ever been, is already headed in something of an opposite direction. As he points out, filmmakers know magnetic film, and some will probably always stick with magnetic film. But then again, producers are always looking for more cost-effective ways of doing things, and sound quality has been on their minds of late as well. Some of the younger people in the business are definitely coming around.

They'd better come around before *Tron II*, however, or it may be that all they'll find where Frank Serafine was for *Tron I* will be a cloud of dust. ■

Sound Engineering for Theatre and Film

The following is a report on two British installations.

IN THESE DAYS of heavy specialisation, from high-school onwards most operational sound engineers are happy enough to work away at the specific aspect they know best. For some *db* readers, this may mean the busy confines of the recording studio. Others, in film and theatre sound, tend similarly to occupy themselves with the problems and tech-

niques peculiar to their medium, and very little cross-fertilization seems to take place.

It has been pretty much the same with sound equipment designers and manufacturers—until recently. Now I can see many instances where designers of mixing consoles, for example, are going out of their way to study the special needs of film and theatre engineers instead of merely offering them re-jigged sound-studio consoles.

One British firm which has been landing a number of prestige design commissions in a wide range of sound applications lately is Technical Projects, a group within Theatre Projects Services, Ltd. Knowing that they had recently designed a uniquely versatile console for Pinewood Film Studios, I contacted their chief designer, Sam Wise, and was not a little bit surprised when he suggested that we meet up at first at the new Barbican Centre in the City of London—but he had good reason.

British readers will know all about the Barbican Centre for Arts and Conferences. After all, it has been slowly rising up (since work began in 1971) from the rubble of a badly-bombed 35-acre area not far from St. Paul's Cathedral. British taxpayers will also have felt the impact of the 140 million pounds (about \$250,000 US) so far spent, though they have indeed gotten quite a lot for their money.

The Centre includes the magnificent Barbican Hall, seating 2,026 and providing a permanent home for the London Symphony Orchestra, as well as being solidly booked out from its official opening on March 3rd of this year, by artists ranging from Stephan Grappelli to the Grenadier Guards. There is also the Barbican Theatre, seating 1,166 and acting as the new base for the Royal Shakespeare Company. And, The Pit is a small 200-seat studio theatre for experimental productions. There are three small cinemas, a 15,000 square-foot Art Gallery, an open-air Sculpture Court, a new Lending Library, two Trade Exhibition Halls, five Seminar Rooms, restaurants, bars, shops and the Guildhall School of Music and Drama, which has its own 400-seat Music Hall, 300-seat theatre, and numerous rehearsal and teaching studios.

THE BARBICAN THEATRE

Sam Wise's reason for meeting me at the Barbican Centre soon became apparent, as he conducted me up-and-over the

John Borwick is db's European editor.

ANALOG PROBLEMS?



VOLTAGE PROGRAMMABLE ACTIVE FILTERS

Filters: HP-LP-BP

Attenuators: L-Pad lin/log

Oscillators: Low distortion sin/cos

100/1 control range • opto isolated control

• Infinite resolution •

2% typ acc • 1Hz — 100 KHz

\$65 to \$140

VOLTAGE VARIABLE SYSTEMS

251 Windward Passage/Clearwater, FL 33515

(813) 461-2539



Figure 1. The new console in Pinewood's Theatre 2.

double-height (109 feet) scenery flytower, where nearly 80 bars can be raised and lowered at pre-programmed individual speeds from a single control desk. Theatre Projects consultants were responsible for all the technical facilities in the Barbican Theatre, and the Technical Projects Division designed all of the sound communications hardware.

Though rehearsals were in progress for the opening production (Shakespeare's *Henry IV*), he was anxious to show me some of the finer engineering features—and to check that everything was in working order for opening night. Both the lighting control and sound-routing functions are computer-aided, and this means that the usual complex lighting control desk looks much simpler than usual, even though 480 dimmers are handled.

The computer memory for the sound system has to cope with amplification of voices, an off-stage orchestra, and the wide range of sound effects demanded in modern theatre. The sound effects originate from banks of two-track and four-track tape machines, as well as from NAB cartridge decks. The mixing console, designed by Technical Projects and built by Rank Strand Sound, has 24 input channels, with left and right outputs routed in any combination to ten group masters, selectable to 26 output channels. All these outputs, with individual faders, have racked power amplifiers driving a network of installed and mobile loudspeakers. The main reinforcement loudspeaker arrays comprise multiple horns and bass bins, suspended over the proscenium arch, and supplemented as necessary by portable units on stage. To give some idea of the complexity of theatre sound installations in general, and of ultra-modern designs in particular, there are additional low-level drivers recessed into the walls all along both sides of the auditorium. Unusually, the architects have eliminated seat aisles completely, so that there is a separate door for audience entry at both ends of *each* row. Technical Projects had to design a recessed speaker enclosure to go into the narrow wall space at every door. This space is about 14-in. x 4-in. x 6-ft.

Get Aligned Stay Aligned with STL precision magnetic test tapes

These dependable tapes are used by broadcasters, recording studios, equipment manufacturers, governments and educators throughout the world. Widest variety...Alignment, Sweep, Pink Noise, Level Set, Azimuth and Flutter/Speed. Available on reels, in cartridges and in cassettes. Also, the Standard Tape Manual & the Magnetic Tape Reproducer Calibrator.

Phone for fast delivery or free catalog.



STANDARD TAPE LABORATORY, INC.

26120 EDEN LANDING ROAD #5, HAYWARD, CALIFORNIA 94545 • (415) 786-3546

Circle 34 on Reader Service Card

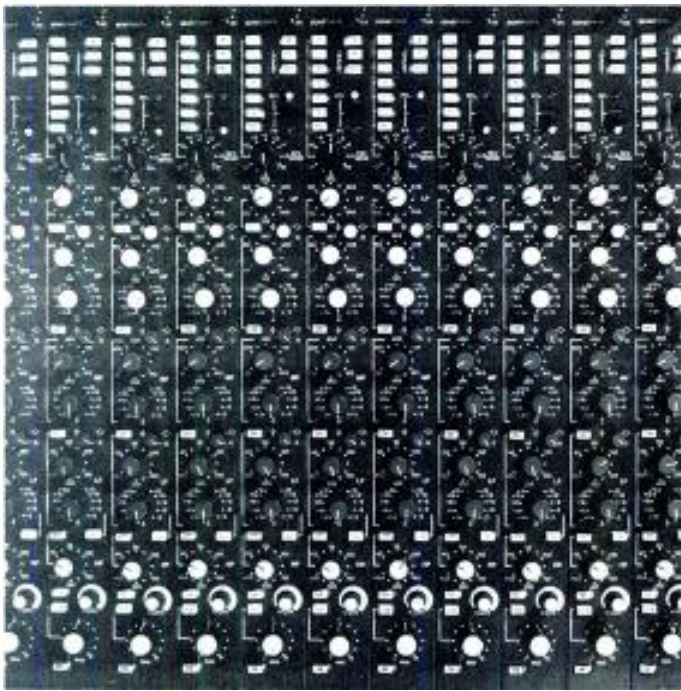

Figure 2. Views of the input modules.

Without memory, source-to-speaker routing would have needed about 850 switching pushbuttons, but the micro-computer can store 199 cues and the sound engineer can set these by using a handy calculator-type keypad. LED illumination of the input/output pushbuttons allows the engineer to over-ride the memory or check the current preset state or the next cue.

For the stage manager and his team, Technical Projects designed a special modular communications centre on a 19-inch rack. The system includes a four-channel intercom, a complex paging system, and a European-type cue-light system. To provide flexible two-way paging, the unit is able to sense when any satellite position is trying to gain access to the system. Based on eight priority levels, each with multiple access points, it can allow the caller to speak, to route his audio as required, and to indicate to other locations (via LEDs) that the system is in use. The signalling system enables anyone using an access point to know whether the system is already in use, and whether their call has been successful. Background music or show relay feeds are muted as appropriate.

Priority routing is determined by cord patching, and can be expanded to any number of users. The four-channel intercom can feed a number of loudspeaker locations as well as belt-pack headset users, and the cue-light system is patchable to enable the stage manager's cue key layout to be sensibly arranged: quite an installation.

A UNIQUE FILM STUDIO PROJECT

The design carried out for Pinewood Film Studios was even more spectacular, and emphasized even more the difference between work for other media and the typical recording studio. The kind of post-production dubbing nowadays needed for such famous Pinewood soundtracks as *Fiddler on the Roof*, *Superman*, and all the James Bond movies is so complicated that three sound mixers usually sit side-by-side and handle different track elements simultaneously.

FIGURE 1 shows the Technical Projects console design now installed in Pinewood's Theatre 2, where they carry out the mixing in a cinema-type environment with the latest film projection and loudspeaker equipment installed. In the technique used at Pinewood, sprocketed film replay-only machines are loaded up with all the audio material to be mixed in preference to multi-track tape recorders. The material will include wild tracks recorded during shooting, post-sync dialogue, music, and effects of all kinds. The machines must run back and forth in accurate synchronism with the projected picture, and be

capable of offsetting as determined by trial mixing runs.

The final mixdown will usually contain separate tracks for dialogue, music, and effects (recorded on three separate 35mm magnetic film machines in sync), and with subsequent re-mixing to suit the distributors' requirements in terms of release-print format (mono, stereo, etc.). Up to seven channels will be needed for a modern spectacular, where there will be five speakers arranged behind the screen, and others in a left-right distribution in the auditorium.

Such audio complexities arise from the need for the sounds to line up with the more-critical visual images, and the need for subtle panning of sounds to be laced with chosen amounts of crosstalk to match the changing width of the visual image.

The console provides for 60 channels, divided between three operators, with 32 output groups routed to three 6-track recorders. The total length is 18 feet (5.5 metres) and each operator's position is about 3-feet wide, with standard 19-inch rack sections between them, and an angled wing at one end for group output modules and patching jackfields.

This being very much a custom design, the wishes of Pinewood's chief dubbing mixer Gordon McCallum and his team dictated the console functions and ergonomics. FIGURE 2 shows a batch of channel module strips which are superficially very much like those on a conventional desk. There are differences, however. For example, inputs are line-level only. Microphones are seldom used in the film-dubbing situations, and so a patchable row of six microphone inputs on the jackfield is all that is needed.

Next down from the input sensitivity switch is a phase-reverse switch, and buttons to make the source insertion points either pre- or post-equaliser. The normal pre-fade listening (PFL) facility has been made more elaborate, to cope with foreign-language dubbing requirements where clean feeds of music and effects tracks to the monitors may need to be available at the same time as original dialogue tracks are muted, and the second language dubbed in in-sync.

Six numbered routing buttons select the chosen reverb device, with pre- post-fader switch and reverb-send level control. Then comes a top cut (low-pass) filter control, with selectable

5 dB frequencies from 1.5 kHz to 15 kHz, and the main equalizer comprising three parametric sections having a very wide range of width (Q) characteristics. Care was taken to make the level, frequency and width controls independent of each other, and to use a constant-percentage bandwidth law so that the effects will sound consistent in width at any frequency. The graduated size and height of the three boost/cut, frequency and

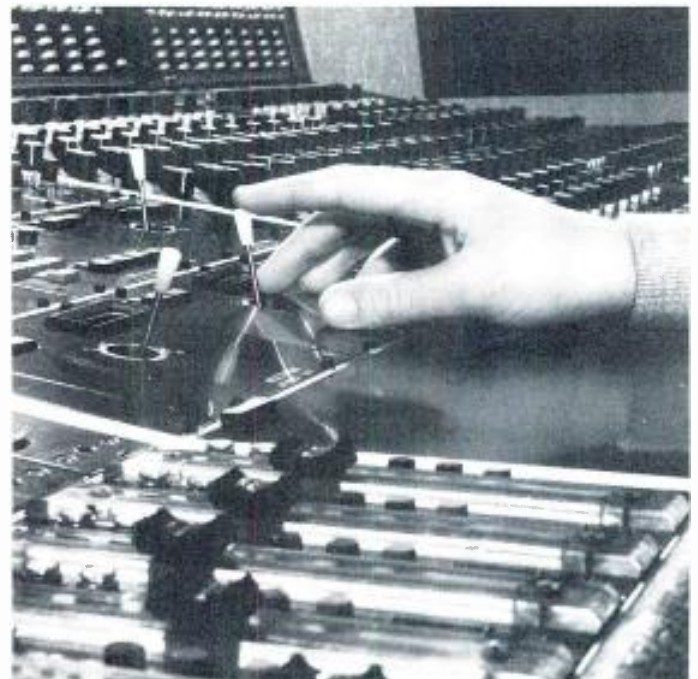

Figure 3. "Multipan" multi-channel programmable memory panning system joysticks in use.

discreetly discrete ...

API SERIES 4024

Design discretion
dictates the use of
all discrete components
in the main signal path
for true
audio integrity.

Only API uses all-discrete
components exclusively
from mic pre-amp
to line output driver.

Our way
costs a little more,
but our console's
sound quality
is unsurpassed
by any other,
at any price.

Contact us for a discreet,
discrete listening session.



A subsidiary of
Atlantic Research Corporation
2100 Reston Avenue
Reston, VA 22091
(703) 620-5300 • Telex 90-1941



Circle 35 on Reader Service Card

www.americanradiohistory.com

width knobs can just about be seen in FIGURES 2 and 3. This was one of several features designed to help the operators, who must direct most of their attention to the projected picture.

This also explains the absence of conventional level meters on the console, as well as its restricted height. Technical Projects specially developed large bar-graph type meters (24 level steps in 8½ inches), which actually hang above the screen in the line-of-sight of all three operators, about 15 feet away from the console itself. Both VU and PPM characteristics are provided with gain states and zero references independently selectable by remote control. There are 30 "thermometer" modules in a four-foot enclosure.

The input patch bay of 500 jacks is situated against the wall behind the operators, and interfaces 78 reproducer output lines to the 60 console inputs. The Dolby encoders and sixty A-type 360 noise reduction systems are linked to a route-proving system which measures and adjusts the Dolby-tone levels, as well as verifying arrival at the correct location.

MULTIPAN

FIGURE 3 shows a Pinewood console joystick being operated on one of the unique aspects of its automation. Pan-pot operation is such a feature of modern film production that it can easily take up most of an operator's energies. So the design set out to automate this task, as well as level settings, via voltage-controlled amplifiers, just as computer-aided mixdown techniques are used in sound recording. Technical Projects, besides designing three-channel panners on all the input modules, came up with a novel "Multipan" technique, capable of panning over any number of loudspeakers. The law of the panning action is programmable to suit the application and given layout of loudspeakers, and panning movements can be memorized using any of the standard automation systems (Fadex/Allison in this case). This degree of flexibility finds application in both types of Technical Projects clients—the theatre where each show may have different requirements and odd speaker layouts dictated by theatre acoustics and topography, and film-dubbing where different cinema speaker formats may be demanded from one film soundtrack mix.

4 CHARACTER ALPHA DISPLAY PROMPTS FOR OPERATIONS AND DISPLAYS KEYED IN INFORMATION

MODE SELECT SWITCH WITH KEY

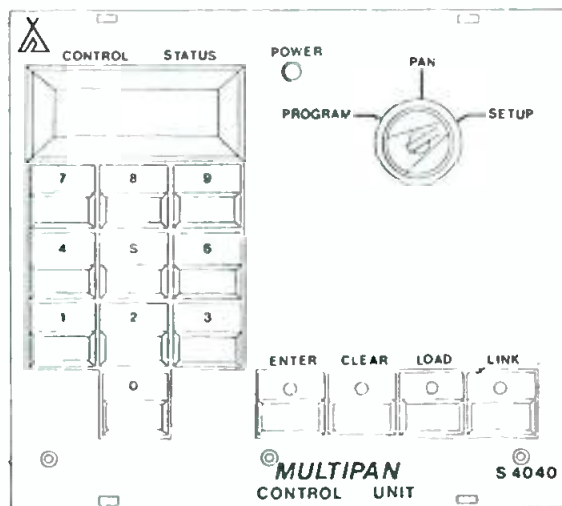

PUSHBUTTONS FOR SELECTING AND ENTERING LAWS AND ASSIGNING MASTER/SLAVE RELATIONSHIPS

Figure 4. Diagram of Technical Projects' Multipan control unit.

The Multipan laws (supplied in PROMs by Technical Projects) combine acoustical, electrical, and operating requirements so that the control voltages produced by every position of the joystick will line up with where the operator expects the sound to move. When interfaced with a console memory system, each panner joystick appears as a pair of channel faders, one for X-axis movement and the other for Y-axis, controlling up to eight VCAs. A "local status" on the joystick panel shows the chosen law and whether that panner—there are six on the Pinewood console—is an active master or a slave being controlled by another joystick. This allows several sources such as music, dialogue, and sound effects to be moved in synchronism. The usual read and write modes are selectable, with a four-character display to guide the operator through the correct sequences, so that difficult panning sequences can be rehearsed, stored and run automatically when required.

AUTOMATION CONTROL PUSHBUTTONS. AN INTERFACE TO ANY SYSTEM CAN BE SUPPLIED

4 CHARACTER ALPHA DISPLAY. DISPLAYS MASTER/SLAVE CONDITION AND ASSIGNED LAW

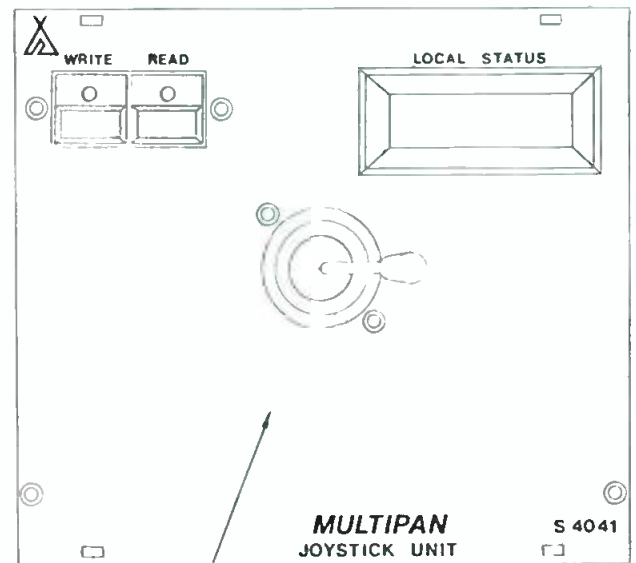

X,Y JOYSTICK

Figure 5. Diagram of Technical Projects' Multipan joystick unit.

In practice, Pinewood usually begins with a preliminary pseudo-stereo mix to get the panning and positioning right. At the subsequent level-and-balance dubbing stages, it is therefore a great benefit to have the panning already in the computer can. Thanks in no small measure to the spade work carried out by Dolby Laboratories, the practicality of noise-free optical prints has made stereo optical soundtracks a preferred format for 35mm stereo—with six-track recordings on film for (Dolby) 70mm stereo. To allow for the different degrees of sophistication available in different cinemas, Pinewood and Dolby have collaborated on a format which uses the upper frequency band on the spare tracks for surround-sound information. The print will therefore play normally in a modestly-equipped cinema, yet yield full divided-surround stereo in a cinema having the necessary decoders and auditorium loudspeakers. The demonstration given me by Sam Wise was very impressive, and he also showed me a rotary panner (circular knob) version of the Joystick, with a separate width control. Already used on a number of important films, including Blake Edwards' "Victor/Victoria," the new console is busy on Pink Floyd's "The Wall" movie as I write, and is a praise-worthy example of audio engineering in the service of Sound with Images.

The Needle Knows

Even when your ears can't tell the difference, your VU meters can.

Which is why we test every reel of our 2" Grand Master® 456 Studio Mastering Tape end-to-end and edge-to-edge. To make certain you get a rock-solid readout with virtually

no tape-induced level variations from one reel of 456 to another or within a single reel.

No other brand of tape undergoes such rigorous testing. And as a result no other brand offers you the reliable consistency of Ampex Tape.

A consistency that lets you forget the tape and concentrate on the job.

Ampex Corporation, Magnetic Tape Division
401 Broadway, Redwood City, CA 94063
(415) 367-4463

AMPEX

Ampex Corporation • One of The Signal Companies 

**4 out of 5 Professionals Master
on Ampex Tape.***

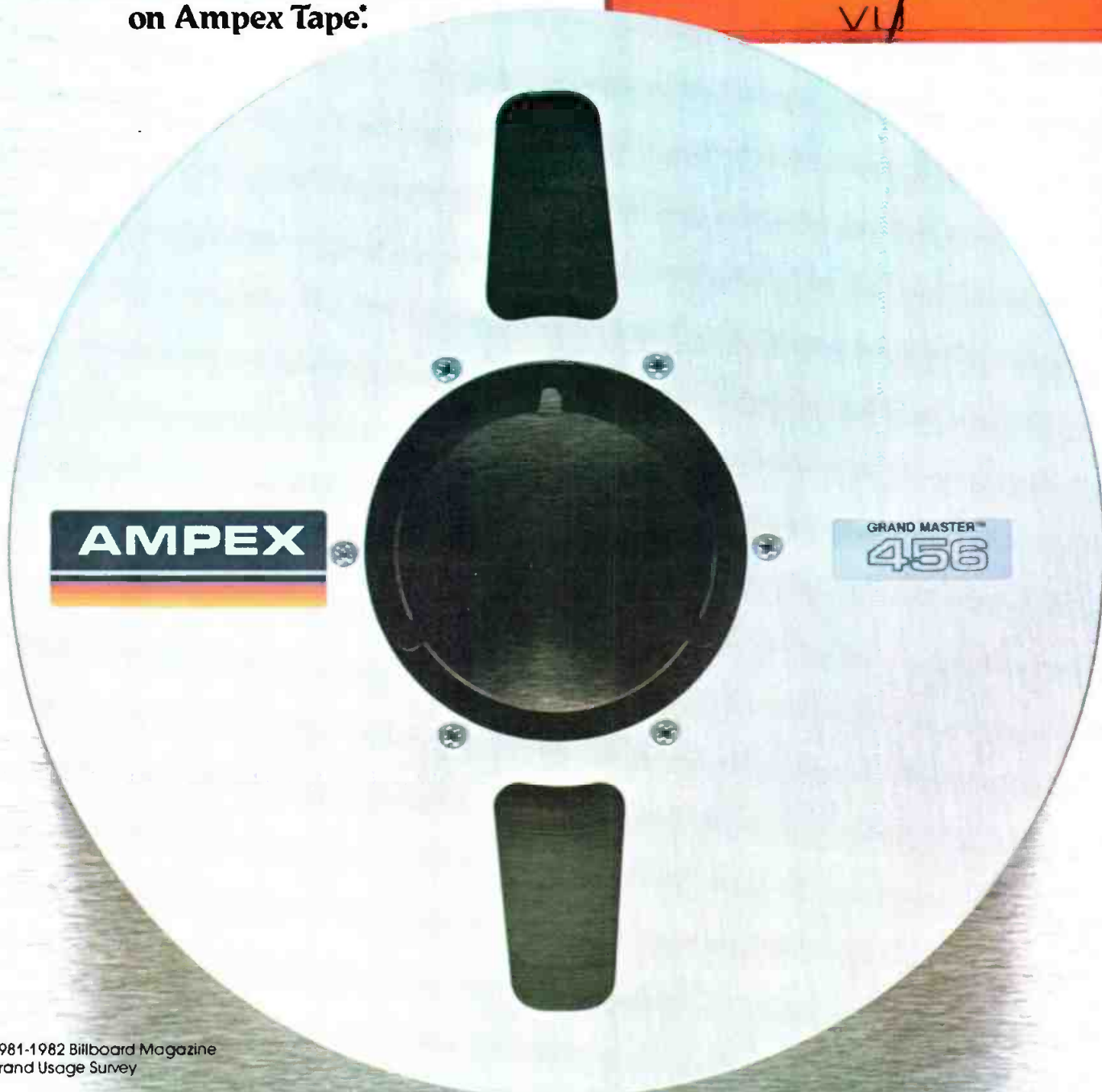
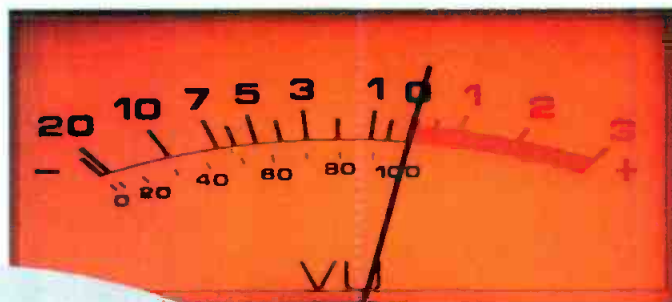

*1981-1982 Billboard Magazine
Brand Usage Survey

Circle 36 on Reader Service Card

www.americanradiohistory.com

Countdown to the 21st Century

Things can get rather hectic for the audio crew as air date approaches, as Ed Greene can no doubt attest to.

EPCOT Center is a new 27,000 acre part of Walt Disney World in Florida devoted to an Experimental Prototype Community Of Tomorrow, from which the acronym is derived. Part of the project is Future World, a complex of six buildings that includes the world's first geodesic sphere, the 180 foot diameter "Spaceship Earth," the Land Pavilion covering six acres, and the World of Motion exhibit which is 60 feet high and 320 feet in diameter. Another part of the project is the World Showcase with representative samplings from different countries showing their architecture, restaurants with authentic food, and a circlevision film. Conceived by Disney before his death 16 years ago, the project explores the future of man on this planet in terms of food, energy, travel, communications, and social structure. The EPCOT Center opened to the public October 1, 1982.

To celebrate the opening, the Disney organization produced a one-hour musical spectacular with host and principal star Danny Kaye, Drew Barrymore of E.T. fame, musicians Marie Osmond and Roy Clark, astronaut Alan Shepherd, writer Alex Haley, TV personality Eric Severeid, robots SICO and SMART I, the West Point Glee Club, the 450 member All-America Marching Band, and numerous others. The show was produced and directed during the month of October by Gary Smith and Dwight Hemion of Smith-Hemion Productions, well known for their spectaculars and recipient of many Emmy awards. Producer for Disney was Ron Miziker. The credit list is lengthy, but the significant audio credits must include: Chief audio engineer/mixer Ed Greene, of Greene, Crowe & Co.; Group IV Studios of Hollywood. Pre-record and post-score: United Western Studios of Hollywood, Choir overdub: Complete Post, Inc. of Hollywood. Post-production editing, sweetening, and Disney's Studio D. Final mixdown to release master.

This article chronicles the audio production for the EPCOT special and the way it was assembled during a month of virtually continuous activity. The progress is noted by countdown dates prior to the show's air date.

ALTHOUGH PRE-PRODUCTION meetings and planning sessions had been going on for weeks, the actual production of the EPCOT special "The Beginning of The 21st Century" began 25 days before air date with pre-record sessions held in Hollywood's Group IV Studios. The pre-record sessions were done the same as any other recording session and the studio set-up is shown in FIGURE 1. It was a typical television orchestra of 31 musicians playing some really outstanding music directed by Ian Fraser, with arrangements principally by Bill Byers. It was laid down on a 24-track in a very traditional fashion. The tape was not noise-reduced. It was recorded at +5 above 185 nanowebers meter, which Greene finds is a nice area to work in when not using Dolby. The tape used was 3M 250 at 15 ips—which turned out to be a happy combination with these levels. (Ed's standard header format calls for zero-level tones at 700 Hz, 10 kHz, 100 Hz, and 700 Hz again.)

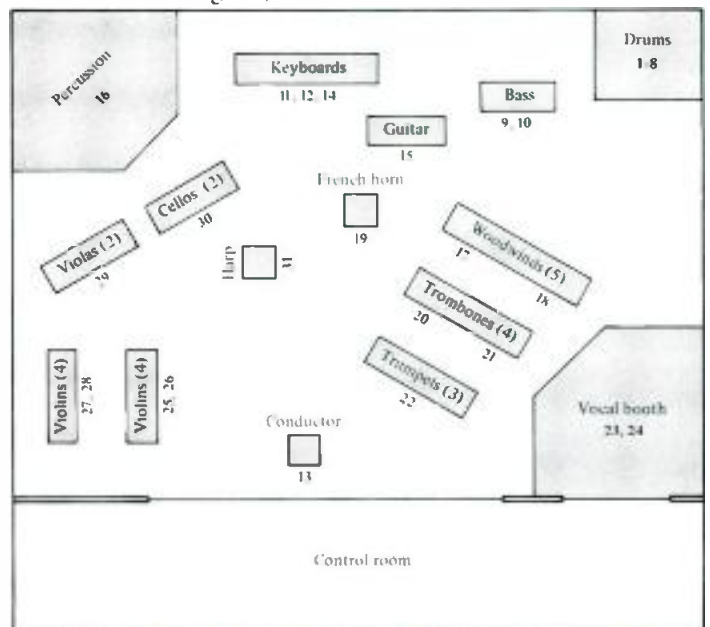

Figure 1. Group IV Studio in Hollywood as configured for orchestral pre-record sessions.

Bruce Mallion is a freelance recording engineer and technical writer.

25 AND COUNTING...

Pre-record sessions occupied the evenings of Countdown Days 25 and 24, after which Greene made a rough mix and cassette dupes for the producers and the show's star Danny Kaye. Kaye had sat in on the pre-record sessions and ran through his vocals, which were recorded on a separate track of the 24-track master for later use as guide vocals at the time of the shoot. The masters were edited in show sequence and all segments were striped with drop frame SMPTE time code. Following this, tracks 19-24 of the edited master were dubbed to a second 24-track tape that would be used the next day as a choir overdub master.

On Countdown Day 23 the choral overdubs were recorded with a 12-voice choir at United Western and following this the masters were taken to Complete Post Production where a rough mix was made.

Countdown Day 22 was spent finishing the pre-mix. At this session, a mix to a four-track tape was made with guide vocals on track 1, choir on track 2, orchestra on track 3, and the audio master tape's SMPTE code on track 4. This four-track tape would be used to play back for cues from the remote truck, which would not have the capability to play back the 24-track session master.

Meanwhile, the crew was busily collecting the audio equipment that would be used for the location recording work at EPCOT-Florida. This included equipment check-out, packing, and preparing for the unexpected. One of the uncertainties of this location job was that the production crew would not have the luxury of operating from the fully equipped Greene-Crowe & Co. remote truck, but would operate with minimal equipment from a remote van they would outfit when they arrived at the location.

Countdown Day 21 was spent traveling from Los Angeles to the EPCOT center and setting up the remote recording facility. Supervising this activity was Joe Kendall, Greene-Crowe's key man in making sure that remotes like this happen without a flaw. He acts as the crew boss on the floor and coordinates the set-up, cabling and check out so that by the time cameras are positioned and set-up, audio is ready to go. He was assisted at EPCOT by some terrific Disney people who helped in every way possible to get what was needed and coordinate with the central computer room that runs EPCOT. When Ed Greene, Gene Crowe and Keith Winikoff (Ed's equivalent on the video side) arrived, they found they had two options. There was a 20-odd-foot refrigeration van trailer available and they could either use that or a 20-foot Winnebago motor home. (Greene-Crowe's own mobile production center was unavailable, due to an

extended West-coast commitment.) They decided that although they would have enjoyed the physical comforts of the motor home, it simply didn't provide enough space for five operating people and the equipment they needed for this show.

The video facility used for this part of the EPCOT special was actually the Digicam division of Greene-Crowe, operated by Winikoff, who is a partner in the company. Greene-Crowe Digicam is designed for highly mobile small systems shoots than can happen anywhere in the world. An interesting "Oh, by-the-way" to the equipment trailer was that it had an air conditioner that would keep the temperature down at about 10°F, and a compressor that doubled as an earthquake generator, shaking the trailer unmercifully. So they shut off the air conditioner and suffered with the heat for the first couple of days. Finally, they scrounged a couple of window air conditioners and fitted them into one of the door areas and were able to cool the trailer that way. They actually built an audio video trailer right there on location. This is not at all uncommon in the business. Probably half the shows Greene is involved with are done in this fashion as opposed to studio productions. They use small systems, small cameras, and essentially produce the show in film or movie style, sometimes with power (in this case they had power available most of the time) and sometimes without, in which case Ed runs the equipment off a little Honda generator.

The audio and video equipment set-up in the trailer is illustrated in FIGURES 2-4. For audio, Ed has his own Auditrionics 110-8 console with a long umbilical cord. This went out to the floor to receive the seven or eight microphone inputs, three or four wireless mics, and a couple of ambient mics. The reason for needing the Auditrionics 110-8 with its 24 inputs and 8 mixing buses for that few microphones is that there was a requirement on several occasions to provide a wide variety of feeds back to the scene. In addition to handling live microphones, Ed had to be able to play back from a four-track recorder containing the pre-recorded studio material, a second four-track containing the production sound he was taping on location, and any of three videotape machines. The four-tracks are Otari MX-5050s that Greene-Crowe has modified to be resolved by time code. They have built their own travel cases for them so they can be shipped without disconnecting the electronics from the transport.

A second four-track was used to record live vocals and dialogue. The reason for the second machine was that they were recording in locations with very high ambient noise levels. Ed didn't feel he could successfully handle the on-location dialogue

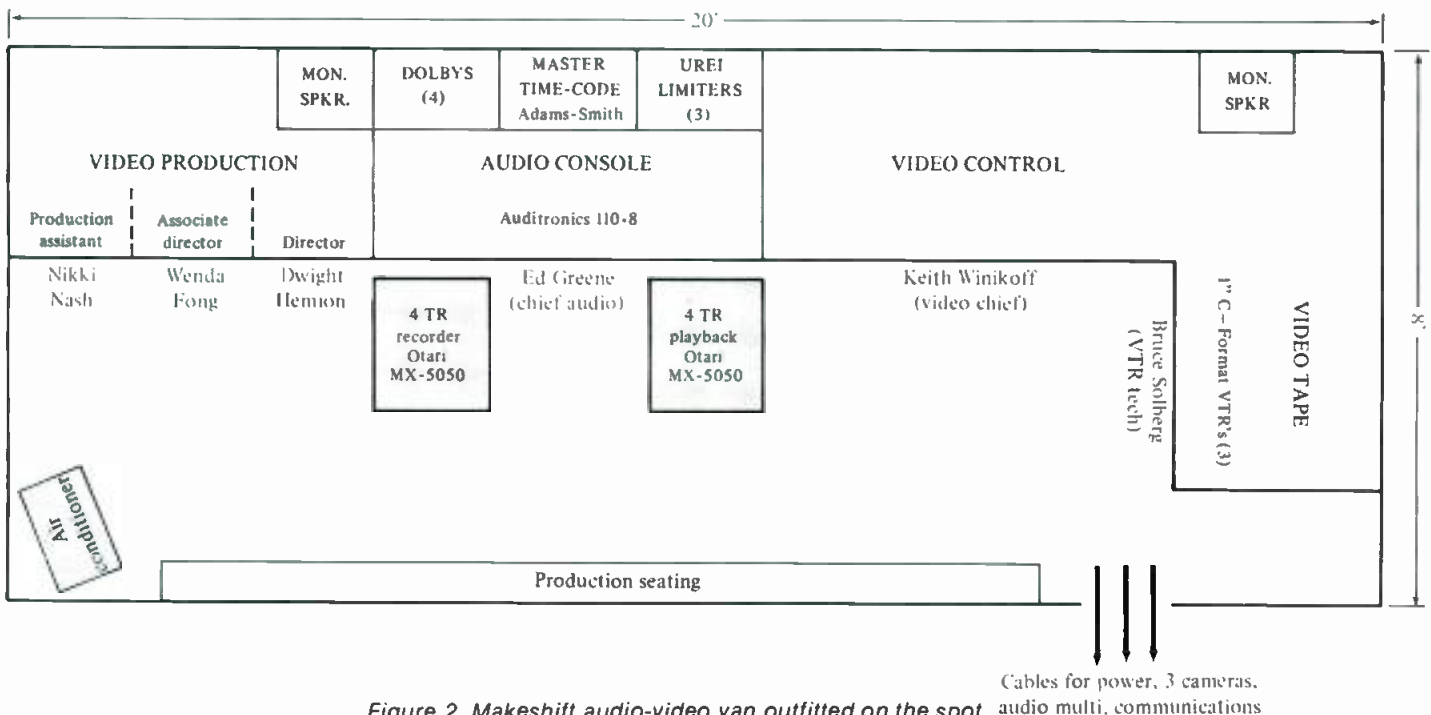

Figure 2. Makeshift audio-video van outfitted on the spot at EPCOT Center in Florida.

Cables for power, 3 cameras, audio multi, communications



Figure 3. Ed Greene records location audio at the Audiotronics 110-8 topped by Dolbys and UREI limiters and flanked by two Otari MX-5050s.

so he isolated it on three tracks of that second Otari so that noise gates, equalizers, and additional mixing could be done in post production. The location machine was recorded with Dolby to provide a clean four-track with SMPTE time code for all the live vocals and dialogue that went down on the show, so Ed could drop those live mics back into the production later on, rather than using the production audio track from the video tape.

Additional equipment in the trailer included the three VTRs. Video monitors were positioned so Greene could see what was going on with the video side. It's important that the mixing engineer see the video from the director's monitoring switcher so he can mix the audio signal to match the director's camera choices. When you're doing audio production for video, you're not just concerned with laying down clean tracks. The more mixing to the scene you can do the better, because the chances are better that the result will *sound* live as well as *look* live. This is so much better than a complete studio pre-record, for example, where you have a copy of the shooting script in front of you but have to guess what the scene will actually look like when they shoot it.

In addition to the four-track audio recorder, Ed also had available the two audio tracks on each of the three one-inch video recorders. He put the composite production audio on one track and the live ambience on the other track, so when the video tape was edited, the ambience would be edited simultaneously. With the actual ambience on the video master, this could be used in post-production editing to achieve a sense of reality that just couldn't be equalled by playing back a studio-recorded tape or doing sound effects and foley work in post-production.



Figure 4. Crowded, built-on-site audio-video van houses video production assistant Nikki Nash and associate director Wenda Fong (back to camera), director Dwight Hemion, chief audio engineer Ed Greene, VTR crew Keith Winikoff and Bruce Solberg in background of 8' by 20' trailer.

The special outputs from the Audiotronics 110-8 included the dialogue mics fed to the recording four-track Otari, the main production mix that went to the three VTRs, the isolated ambient track that went to the VTRs, and the RFIFB (Radio Frequency Interrupt Fold-Back, a little ear-piece that Ian Fraser wore so he could hear Danny Kaye's vocal when he accompanied him on the piano). There was also a PA fold-back that was available on a portable basis throughout the shoot. The director's stage announce went through all those systems so Director Dwight Hemion could talk to the performers.

Greene tried to record as much live ambience right on the spot as he could so as to save time in post-production. A combination of shot-gun mics and fish-poles was used for this. The multiple RF mics used for the primary pickup were omnis, so most of the desired ambience came along automatically. The main concern in handling ambience on a show like this is to be able to hear what you're seeing and *not* hear what you're *not* seeing. Occasionally, there are extraneous noises like airplanes flying over and you do your best to wait those out. The Audiotronics 110-8 was connected by an umbilical to the cart shown in FIGURE 5. When the crew could not get the equipment



Figure 5. Greene-Crowe's audio location cart bristles with antennae for radio mics, shown with Bill, crew chief Joe Kendall, Tom, and Corky.

trailer into the park, a small remote cart on a long umbilical cable allowed them to follow the action pretty well. There were actually two umbilicals, one for power, and the other a 27-pair audio cable.

The remote cart contained the RF receivers for the four radio mics, a hard-wired RTS-PL (Private Line) system, the RFIFB transmitter that goes out to the accompanist's earpiece, several hard-wired lavalier mics and hardline fish-poles, the playback speaker and its power amplifier, and the power mults.

The cart carried RF receivers because 90 percent of the show was done with four wireless Vega Dynex systems with the tiny Tram mic, which for that kind of show is a very desirable piece of gear. Greene had to clear the use of the radio frequencies with Disney, of course, because they use literally hundreds of frequencies in the park for controls and communications. In addition to the mic frequencies, audio also had its own radio communications. The location cart also had playback speakers and amps which allow for playback of the audio track, with or without the vocal, directly on the floor.

The stage announce—either from video director Dwight Hemion or from Greene—also used this system as did the producer, Gary Smith, who wore a radio mic. So there was a lot of trailer-to-floor communication. Even the choreographer wore a radio mic so that he could communicate with the director and crew during staging. This ease of communication made it possible to make many creative decisions quickly, without having to “break” the cast and crew for staff conferences.

When Greene arrived at Florida for the shoot, he had the four-track reduction from the pre-record master with him, containing the guide vocal (or pre-recorded vocal if you want to call it that), the choir, the rough mix of the orchestra, and the

SMPTE time code. The 24-track master was brought along just in case any kind of a mix or overdubbing had to be done on location. Underneath the Magic Kingdom, Disney's Studio D has 24-track capability, so any needed multi-track work could be done there. Studio D is part of extensive audio and video facilities at Disney World, directed by Tom Durell. He and his staff literally worked day and night to assist in this production, earning Greene's personal and professional respect.

20 AND COUNTING...

Countdown Day 20 concluded with survey trips to all the shooting locations by both audio and video crews to check out logistics. Countdown Days 19 through 14 consisted of shooting the many bits with Danny Kaye and cast, as well as groups of foreign students. Most of this was standard from an audio point of view, but a couple of bits required departures from the plan or made full use of state-of-the-art techniques and hardware.

One of the more complicated bits was for a scene where Danny Kaye was singing a song live to Drew Barrymore. There was already a recorded music track for that, but it was a quiet song and not in very strict tempo, and Kaye felt that he would be too restricted by a fixed music track. In place of that, he asked that a live piano be brought to the location that only he would hear. Audio would record that live, record his vocal live, and replace the piano later on with the previously recorded orchestra tracks (which is what was actually done in post-scoring). That was a bit of a challenge. The location pianist was Ian Fraser, the music director of the show, and he provided off-camera accompaniment to Danny as he sang, using a Yamaha electric piano that only Danny could hear by means of the RFIIB.

Greene remarked upon the unique talents of this musician. "To me, Ian Fraser is the epitome of the ideal music director for this kind of a show," said Ed, "because he pays incredible attention to the many details that are necessary to make the production seem smooth and effortless when you hear it. If you listen to a show like this before we add the post-score music, you'll note that what comes off the pre-record sessions seems like disconnected bits and pieces. What Fraser added on location and in post-score made the music seem to flow as a continuous whole."

Another technically interesting piece of business was a song called "Showcase of the World" in which Danny Kaye goes from one country to another—Canada, England, France, Mexico, China—in four to ten-second leaps. This one song was shot over a two-day span on Days 17 and 16. The trick here was to keep track of all the bits and pieces. Ed had the capability in the truck of playing back the recorded tracks resolved, taking the time code from the pre-record audio tape and inserting it into the user-bit area of the master video and audio time code. This would make it possible for editor Andy Zall to display the time-of-day SMPTE code to make sure he had the proper take, and then edit with the information in the user-bit code to insure

accurate timing and sequencing of all the program segments. Another interesting use of electronics was for ship-to-shore recording where Danny Kaye speaks to the land-based cameras from one of the boats that cruise about the World Showcase lagoon. Here, two-way communication was by way of radio mics with Kaye hearing through the RFIIB. A part of Roy Clark's group was also shot from land while touring in a boat. By the end of Saturday, October 9—or Day 14 before the program's air date—most of the scenes are shot.

13 DAYS TO GO

Staff and crew returned home to Los Angeles on Countdown Day 13 with the master video tapes and audio tapes consisting of the 24-track pre-recorded orchestra and chorus, the four-track dialogue tapes and five vocals recorded in the field, all striped with time-code. These are brought to the editing facility, Complete Post. On Countdown Day 12, director Dwight Hemion and producer Gary Smith go into video post-production and start to edit their show.

When this is finished, on Countdown Day 8, Ed Greene starts the audio sweetening and finishing on that portion of the show (about 40 minutes of material). This begins with a lay-down from the edited video master to a ¼-inch video cassette that he can use as a working copy, and a new 24-track tape that he then assembles as a sweetening master. This will have time code on track 24, the video tape's audio on tracks 21 and 22, and he will build on this tape the finished mixed music with vocals isolated, choir, lead singer, the finished mixed dialogue from the location four-track, and whatever sound effects are needed. This material is assigned to about fifteen tracks of the sweetening master. This is the easy part.

Then comes the post-scoring session. This involves going back to the same pre-record studio, setting up the orchestra the same way, and adding all the intros and bridges and bits and pieces that could not have been done in pre-record because the precise timing of the various scenes was not known. This is essentially "scoring to picture," much as it is done in film-industry practice, and is an extremely laborious and time-consuming task (one ten-hour session) involving some 20 or 25 segments all scored, played and recorded to fit precisely into the existing time slots in the show.

In the post-scoring session, Ed plays back the video cassette working copy, the 24-track sweetening master he made in post-production, and makes yet another 24-track master containing all the post-score music. This tape has the same time code and track assignments as the sweetening master. Then he goes back to the post-production facility and mixes all those music tracks into the sweetening master reel. By Countdown Day 5, he has all the audio for the first 40 minutes of a one-hour show on a single 24-track master, as yet unmixed. It remains now to return to EPCOT in Florida on Countdown Day 4, shoot a segment featuring Marie Osmond, and the finale with Danny Kaye conducting the 450 piece All-American College Marching Band

Ed Greene on equipment selection

"I'm amused at how many people ask me, 'What's your favorite tape recorder?', or 'What's your favorite console?', as though I knew some magic combination of black boxes that would insure success. My stock answer is that my favorite console is the console I'm sitting behind at that moment, no matter whose it is or how many channels it has. Sure, maybe I'd like to have something else, but that's not the point. The important consideration is whether I'm able to do a credible job with the equipment available. For example, most of the location audio for this Disney special is being recorded on my own Auditronics 110-8 location board which was bought for just this type of application where we don't have a large truck, but do have more than "suitcase" or "battery only" capability. It is serial number 001 and has over a million miles on it and many trips around the world. It has always worked when it comes off the airplane, and to me as a working professional, that's most important."



Figure 6. Looking over Roy Clark's shoulder at the crew shooting him for the EPCOT special while floating on a boat in the World Showcase Lagoon.

and the West Point Glee Club, and mix the audio for the entire show.

4 DAYS AND COUNTING...

With four days remaining before the show airs, the schedule gets hectic. Ed gets off a plane in Florida at 4:00 in the afternoon and by 6:30 is at the board recording Marie Osmond's vocal to a four-track work tape, which was finished by about 2:30 in the morning. Marie would lip-syne to this vocal for the shoot the next day. By 6:00 that same morning he was out in the field setting up a remote video truck rented from TCS in Pittsburgh. This particular unit was chosen to permit final video editing of the last two segments on location of the master that would air ship to New York for broadcast three days later.

While video shot the Marie Osmond piece, Ed took his 24-track audio master down to Studio D at Disney World and mixed the first 40 minutes of the show. This was a Sel-Sync mix to two open tracks of the 24-track tape. Greene made it a stereo mix more for his own pleasure than anything else, as the final release would, of course, be mono. It was now less than 72 hours to airing, but Ed was fatigued so he slept from 6:00 to midnight, and from then until 6:00 in the morning of Day 2 finished mixing the first 40 minutes of the show. By this time the Marie segment from the previous day's shoot had been video edited, so he laid that picture and sound into the master.

The next activity was shooting the finale with the glee club and marching band. Because of the physical problems in recording that live, it was decided to pre-record that segment also. By around 1:00 in the afternoon of Countdown Day 2, Ed had overdubbed the marching band on to the basic rhythm track, which to his surprise and pleasure recorded quite well with a pair of PZM microphones sitting on a brick wall in EPCOT's American Pavilion. This was overdubbed on the same four-track Otari used before, on a tape that had the pre-recorded orchestra on it plus a time-code track, leaving one open track for the band, and one for the 100-voice glee club.

The next piece of business was one of the most interesting from an equipment point of view. Tom Durell of Disney had rigged up an ordinary golf cart to support three cameras. Ed stacked on to this assemblage his four-track and Tom's rather hefty sound system and drove to a spectacular setting at Communicore where there's a big fountain in front of the geodesic sphere known as "Spaceship Earth." This scene was to be a night spot with choreography combining both choir and band with Danny Kaye conducting to the pre-recorded track. Ed recorded the live sound also, using several ambient microphones, and the combination of the pre-record and live sound was used in final mix to achieve the massed sound used to end the show.

By now it is less than 48 hours before airing. Greene went back to Studio D underneath the Magic Kingdom to mix Marie's segment, which took until after midnight. Video hadn't finished editing the finale yet, so audio laid out for some well deserved rest. This gave Ed the following morning to finish the audio mixing for a noon screening on Countdown Day 1 by Danny Kaye and the Disney staff. A few changes were requested at the screening, mainly enhancement of the choir in the finale. Since the finale was not only recorded in the field but mixed in the field, some of the tools Greene would normally use in post-production were not available, such as EQ, echo, Harmonizer, etc. But in the three hours remaining before the tape had to ship to New York, he was able to enhance the band and choir sound considerably and meet the shipping deadline.

Group IV Trident A Main Console Input/Output Assignments for Pre-record Session

<u>Input</u>	<u>Microphone</u>	<u>Instrument</u>	<u>Output</u>
1.	E-V RE-20	Bass drum	1
2.	Shure SM-57	Snare drum	2
3.	Shure SM-57	High hat	mixed
4.	Shure SM-57	High tom	
5.	Shure SM-57	Middle tom	left &
6.	Sennheiser 421U	Low tom	right
7.	AKG 452 (with 10 dB pad)	Left overhead	to 3 and 4

8.	AKG 452 (with 10 dB pad)	Right Overhead	
9.	Direct feed	Electric bass	5
10.	Sony ECM-50	Acoustic bass	5
11.	AKG 414 (with 10 dB pad)	Acoustic piano	6
12.	AKG 414 (with 10 dB pad)	Acoustic piano	6
13.		Conductor's mike	—
14.	(from Sub-mix 1)	Electronic keyboards	7
15.	(from Sub-mix 2)	Guitars	8
16.	(from Sub-mix 3)	Percussion	9
17.	(from Sub-mix 4)	High woodwinds	10
18.	(from Sub-mix 5)	Low woodwinds	11
19.	Sony C-37	French horn	12
20.	Sony C-37	Trombones 1 and 2	13
21.	Sony C-37	Trombones 3 and 4	13
22.	Neumann U-47	Trumpets	14
25.	Shure SM-81	Violins 1 and 2	15
26.	Shure SM-81	Violins 3 and 4	15
27.	Shure SM-81	Violins 5 and 6	15
28.	Shure SM-81	Violins 7 and 8	15
29.	Shure SM-81	Violas 1 and 2	16
30.	Crown PZM	Cellos 1 and 2	17
31.	AKG 452 (with 10 dB pad)	Harp	18
23.	AKG C-24 (one element only)	Vocal 1	19
24.	Neumann U-87	Vocal 2	20
		Left Monitor Mix	21
		Right Monitor Mix	22
		Click Track	23
		SMP1E Time Code	24

Group IV Sub-mix Input Assignments for Pre-record Session

<u>Input</u>	<u>Microphone</u>	<u>Instrument</u>	<u>Sub-mix</u>
1.	E-V RE-15	Celeste 1	1
2.	E-V RE-15	Celeste 2	1
3.	Direct feed	Fender Rhodes	1
4.	Direct feed	ARP Omni	1
5.	Direct feed	Prophet	1
1.	Sony C-37	Electric guitar	2
2.	Shure SM-57	Acoustic guitar, banjo	2
1.	Sennheiser 421U	Percussion 1	3
2.	Sennheiser 421U	Percussion 2	3
3.	Sennheiser 421U	Percussion 3	3
4.	Sennheiser 421U	Percussion 4	3
5.	Sennheiser 421U	Percussion 5	3
6.	Neumann U-67	Timpani	3
1.	Shure SM-57	High woodwinds 2	4
2.	Shure SM-57	High woodwinds 3	4
1.	Shure SM-57	Low woodwinds 1	5
2.	Shure SM-57	Low woodwinds 4	5
3.	Shure SM-57	Low woodwinds 5	5

AIR DATE

On Day 0, the date of the broadcast, the last piece of business was unique for a show of this type, and that was to prepare for the live minute that would open the show. This was fairly simple compared to the rest of the show as it featured only Danny Kaye dialogue picked up by radio mics (there were two in case one failed; neither did!) and one ambience mic used to pick up the sound of crowds and bands playing for the opening celebration going on in the background. This was mixed and fed direct to a Disney satellite located on the premises.

For audio mixer Ed Greene, the show not over at this point, as there will be further post-production in preparing different versions of the production for international distribution. But it's now air day, October 23, 1982, and with the CBS network prime-time release of "The Beginning of the 21st Century," the Disney EPCOT Center is officially opened to the national audience. ■

New Products

LOW FREQUENCY SPEAKERS

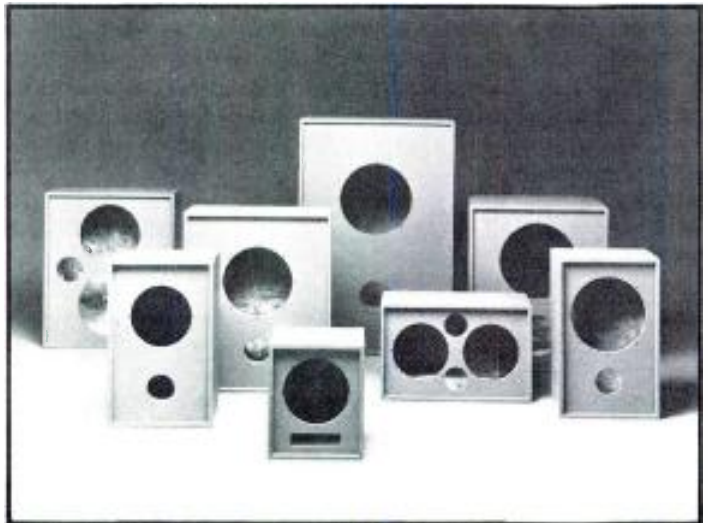

• Altec Lansing has announced the introduction of a new generation of low frequency loudspeakers and matched, tuned enclosures for pro audio and sound reinforcement applications. Designed as integral systems, the speakers of the new 3000 Series were developed in conjunction with the matching 8000 Series loudspeaker enclosures. Each speaker in the new line is engineered for a specific sound application. The six new woofers

include three extended low frequency models: the 12-in. 3124, 15-in. 3154 and the 18-in. 3182; and three high efficiency speakers: the 12-in. 3127, 15-in. 3156 and the 18-in. 3184. The optimally-tuned enclosures range from the 1.5 cubic-foot 8127 to the 24 cubic-foot 8182. The long voice-coil geometry of the 3000 Series reduces distortion by increasing the diaphragm's linear motion, and boosts power handling through increased heat-

dissipation. The 12-in. 3127 pairs high efficiency and compact enclosure size with a frequency response smooth down to 70 Hz (-3 dB) when coupled with the 8127. At the other end of the spectrum, the 18-in. 3182 delivers a response down to 23 Hz (-3 dB) when paired with the 24-cubic-foot 8182 enclosure.

*Mfr: Altec Lansing
Circle 37 on Reader Service Card*

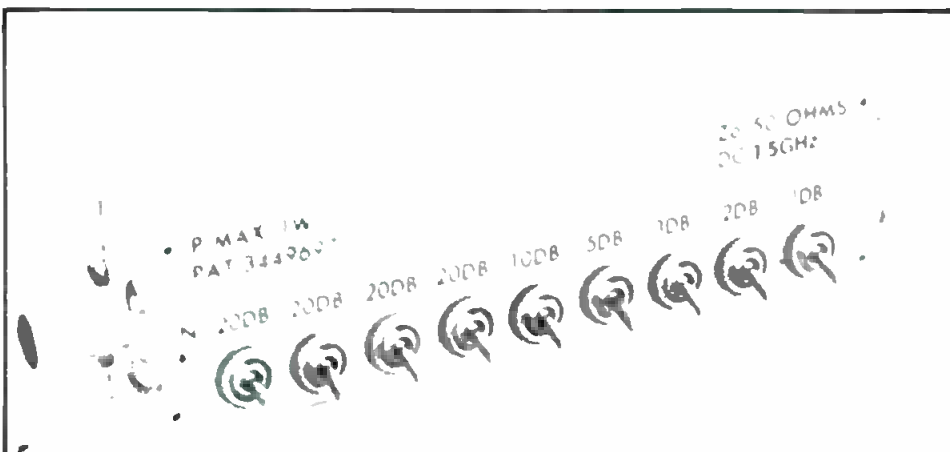

MINIATURE ATTENUATOR

• The 439 Miniature Attenuator has been redesigned to provide a higher frequency range (DC-1500 MHz). Attenuation range is 0-101 dB in 1 dB steps. VSWR is 1.2 in the DC-1500 MHz range, 1.4 in the 500-1500 MHz range, and .8 dB in the 1000-1500 MHz range. The 439 Miniature Attenuator is designed to meet small panel space requirements and is available with BNC connectors (optional connectors: SMA or TNC).

*Mfr: Kay Elemetrics Corp.
Price: \$209.00
Circle 38 on Reader Service Card*

PRO CASSETTE DECK



• The new Studer A710 Microprocessor Controlled Cassette Deck is designed specifically for professional recording and production applications involving the cassette tape format. The A710 features balanced and floating professional line level inputs and outputs, thus ensuring optimum performance when interfacing with recording studios and broadcast production systems. A710 line levels, factory set at +4 dBu (0 dBu = 0.775 V), are internally adjustable over a wide range. Maximum output level is +21 dBu into 200 ohms. Input and output calibrate/uncalibrate buttons are provided on the front panel. When switched to the "calibrate" position, inputs and/or outputs are set to the standard reference level; in the "uncalibrate" position the

front panel input and output controls may be used to provide an additional 10 dB of gain. The A710 transport is a 4-motor direct-drive design. Two quartz-regulated Hall-effects motors drive the dual capstans while two DC spooling motors—governed by the microprocessor—provide constant speed fast wind and rewind, tape tension control and electronic braking. Other A710 features include 3-head design, Dolby B and C noise reduction, programmable start/stop in record or play, 4-segment LED counter and automatic start-of-oxide cueing.

Mfr: Studer Revox

Price: \$2,200.00

Circle 39 on Reader Service Card

STEREO COMPRESSOR/LIMITER

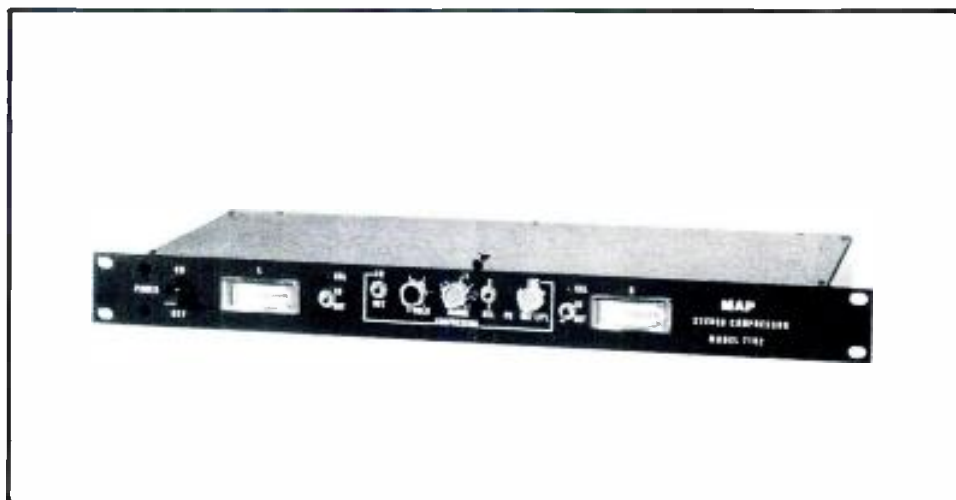

WIRELESS INTERCOM HEADPHONES

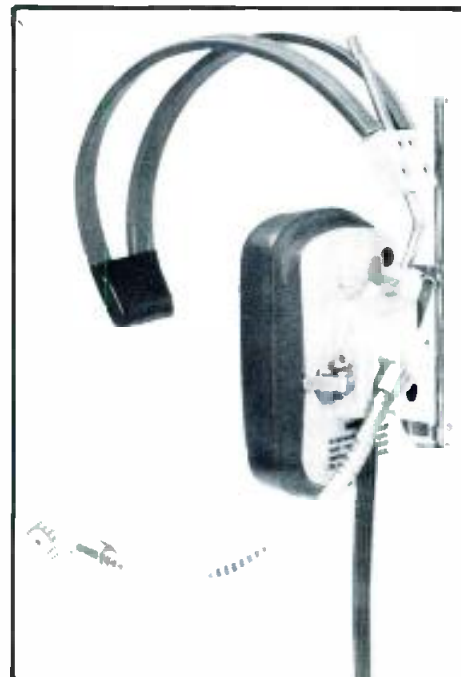

• The R-Columbia-FM wireless intercom headphones provide 2-way intercommunication without wires. Within its range, ¼ mile, the model TR-50 2 can furnish clear 2-way voice communication to any number of similar headphones. Each TR-50 2 has a built-in receiver, transmitter, standard 9V battery supply and 7-in. receiving antenna. A squelch circuit drives the receiver into "quieting" during times of no transmission. Each operator hears his own side tone as an indicator that transmission is taking place.

Mfr: R-Columbia

Price: \$355.00

Circle 40 on Reader Service Card

• The Model 7102 Stereo Compressor/Limiter contains two full VCA units controlled by a single DC source derived from a circuit using a true RMS to DC converter. The input is bridging unbalanced, the output is low impedance unbalanced. The dynamic gain reduction characteristic of the 7102 is a "soft-knee," gradually increasing the rate of gain reduction as more compression is required. All front panel controls are functional: input (threshold) level, compression ratio control, output level control and a slow fast release time switch. Two LEDs show normal clipping levels. Left and right VU meters can be switched to input or compressed output for visual monitoring. A power on/off circuit breaker completes the front panel controls. The 7102 comes with an integral power supply and barrier type terminal strips for audio input and output connections.

Mfr: Modular Audio Products

Circle 41 on Reader Service Card

TRANSPORTATION CASE

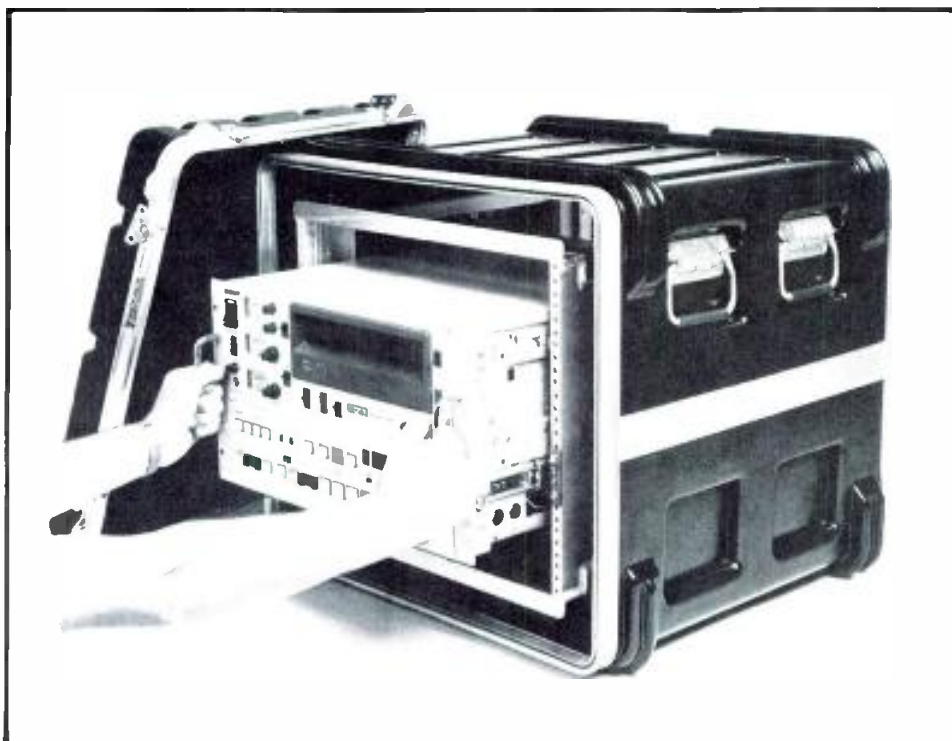

- The Rack-Pack by Thermodyne International is now available with three-tiered sliders that pull out to the length of the case, making the equipment accessible from several angles. It functions as a transportation case with the lids latched in place and as an operating case when front and back coverings are removed. Equipment can be stacked and wired in place, saving set-up time on remote sites.
Mfr: Thermodyne International
Circle 42 on Reader Service Card

- The WR-8724 sound reinforcement mixing console features 24 input channels and ten meters, including one meter which is switchable between echo left, echo right and solo metering for any channel. The unit is equipped with four groups, two master, one mono master, two send and two echo busses for a total of 11 outputs. The WR-8724 also features 100 Hz and 10 kHz equalizer controls on the echo return section. Totally independent mono outputs are also provided from each of the four groups as well as the left and right outputs. For the soloing of channels during sound checks, the WR-8724 is equipped with a switchable solo-to-main mono output function with a separate level control. Another level control is also provided for solo monitoring.

Mfr: Panasonic

Price: \$8,000.00

Circle 43 on Reader Service Card

SOUND REINFORCEMENT MIXER



- The System 14 is a digitally controlled stereo audio console. A digital slide fader and CMOS digitally controlled high resolution logarithmic audio attenuator significantly reduce signal paths, without the disadvantages normally associated with VCA's. Options include 5-frequency EQ on each mixer, remote line selectors, talkback and test oscillators. Standard features include separate mic line pre-amps on each mixer and 3 stereo mixing busses. The System 14 uses d-e audio switching of all programs and monitor functions, which also enables each mixing channel to be turned off and on from a remote location.

Mfr: Broadcast Audio Corporation

Price: \$11,500.00

Circle 44 on Reader Service Card

STEREO AUDIO CONSOLE



Classified

Closing date is the fifteenth of the second month preceding the date of issue.

Send copies to: Classified Ad Dept.

db THE SOUND ENGINEERING MAGAZINE
1120 Old Country Road, Plainview, New York 11803

Minimum order accepted: \$25.00

Rates: \$1.00 a word

Boxed Ads: \$40.00 per column inch

db Box Number: \$8.50 for wording "Dept. XX," etc.

Plus \$1.50 to cover postage

Frequency Discounts: 6 times, 15%; 12 times, 30%

ALL CLASSIFIED ADS MUST BE PREPAID.

FOR SALE

REELS AND BOXES 5" and 7" large and small hubs, heavy duty white boxes. W-M Sales, 1118 Dula Circle, Duncanville, Texas 75116 (214) 296-2773.

BLANK AUDIO AND VIDEO CASSETTES direct from manufacturer, below wholesale, any length cassettes: 4 different qualities to choose from. Ampex and Agfa mastertape—from 1/4-inch to 2-inch. Cassette duplication also available. Brochure. **Andol Audio Products, Inc., Dept. db, 42-12 14th Ave., Brooklyn, NY 11219.** Toll free 1-800-221-6578, ext 1, NY residents (212) 435-7322.

PRO AUDIO IN STOCK ready to ship. Top lines, top dollar trade-ins, clearance specials. Call or write for our prices. **Professional Audio Video Corporation, 384 Grand Street, Paterson, NJ 07505 (201) 523-3333.**

FREE 32pg Catalog & 50 Audio/Video Applic.



Stereo Mono Per Ampl
PWR SUPP. EQ
PHONO, MIC,
TRANS, ACN
TAPE, VIDEO,
LINE, OSC

8-in 2-out, 12-in 4-out, 18-in 4-out
Video & Audio Dist Amps
TV Audio & Recd Prod Consoles

OPAMP LABS INC (213) 934-3566
1033 N Sycamore Av LOS ANGELES CA, 90038

ORBAN and LEXICON. All products in stock. FOR IMMEDIATE DELIVERY. **UAR Professional Systems, 8535 Fairhaven, San Antonio, TX 78229. 512-690-8888.**

USED RECORDING equipment for sale. **Dan (415) 441-8934.**

SNAKES AND CABLES, 100 ft. 16 plus 3 channels, XLR connectors, stage box, highest quality components \$330.00. Mic cables \$12.00 and up. Coax cables, multi-cables, Mic cables, any length or connectors including AMP multi-pin available. **Auburn Corp. (301) 459-1959.**

PROFESSIONAL AUDIO EQUIPMENT

Shop for pro audio from N.Y.'s leader, no matter where you live! Use the Harvey Pro Hot Line (800) 223-2642 (except N.Y., Ak. & Hi.). Expert advice, in-depth parts dept., 3/4" video systems available. Broadest selection such as Otari, Quad Eight, Soundcraft, Tascam and more. Write or call for price or product info:

Harvey Professional Products Division
25 W. 45th Street
New York, NY 10036
(212) 921-5920

MCI JH24B, JH100 16 track, locator, mint \$13,500.00. Electrodyne 16x8 console, \$3,500.00. Ampex AG 440, 7.5, 1/2 tk., \$1,800.00. **(513) 258-2463.**

THE LIBRARY... Sound effects recorded in STEREO using Dolby throughout. Over 350 effects on ten discs. \$100.00. Write **The Library, P.O. Box 18145, Denver, Colo. 80218.**

CUSTOM LENGTH CASSETTE BLANKS made to order featuring AGFA, Scotch, and Magnetic Media tape, any length from C-2 through C-122. For pricelist write **M & K Recordings, Box 195d, Mt. Morris, MI 48458 or call (313) 687-7610.**

ROCKET STUDIOS—All inventory, Teac 90-16, Pioneer 4-2 track, Allen-Heath modified 16 x 8 x 16, Neumann, Ecoplate, AKG, much more, complete studio \$50,000. **(303) 567-2965, (303) 526-1881.**

PROFESSIONAL RECORDING equipment and spare parts, \$500,000.00 inventory clearance, new and used, most items 50% off, Ampex, JBL, Fostex, AKG, EV, Neuman, etc. Send for free list or call. **Accurate Sound Corp., 3515 Edison Way, Menlo Park, Calif. 94025, (415) 365-2843, Telex #34-8327.**

16 CH DOLBY M16—\$8500. 4 Kepexes, 4 gainbrains, in powered mainframe—\$2300. Eventide phasor—\$350. 2 Perception 1/3 octave filters—\$750 ea. Audiotronics 501 26/24 board—\$20,000. Ampex 24 tk 1200 recorder—\$26,000. 2 3M 2 trks—\$1750 ea. 4 1" entry horns and lens, JBL—\$95 ea. Call (404) 223-6107. John.

SERIES 800 Soundcraft 26/8 console spare input, output and power supply used 2 nights, mint condition, paid \$24,000.00, sell \$18,000.00. Call (201) 652-5802, ask for James.

Copies of db

Copies of all issues of **db**—The Sound Engineering Magazine starting with the November 1967 issue are now available on 35 mm. microfilm. For further information or to place your order please write directly to:

University Microfilm, Inc.
300 North Zeeb Road
Ann Arbor, Michigan 48106

WANTED

WANTED: TRANSCRIPTION discs, any size, speed. Radio shows, music. P.O. Box 724—db, Redmond, WA 98052.

WANTED

Full Time **INSTRUCTORS** Part Time
FOR
AUDIO RECORDING TECHNOLOGY

To teach basic and advanced theory and operation of multi-track recording studio equipment.

Audio field experience required. Teaching experience preferred.

Location—historic Greenwich Village.
Salary—attractive; commensurate with background, experience and responsibility of position.

Send detailed resume, including salary history to:

Philip Stein, Director
Institute of Audio Research
64 University Place
Greenwich Village
New York, N.Y. 10003



MAINTENANCE TECHNICIAN wanted for New York recording studio. Call Eldo (212) 279-2000.

SERVICES

ACOUSTIC CONSULTATION—Specializing in studios, control rooms, discos. Qualified personnel, reasonable rates. Acoustilog, Bruel & Kjaer, HP, Tektronix, Ivie, equipment calibrated on premises. Reverberation timer and RTA rentals. Acoustilog, 19 Mercer Street, New York, NY 10013 (212) 925-1365.

MAGNETIC HEAD relapping—24 hour service. Replacement heads for professional recorders. IEM, 350 N. Eric Drive, Palatine, IL 60067. (312) 358-4622.

VIF INTERNATIONAL will remanufacture your Ampex or Scully (Ashland/Bodine) direct drive capstan motor for \$200. Average turn around time—2-3 weeks. For details write PO Box 1555, Mtn. View, CA 94042, or phone (408) 739-9740.

AMPEX FACTORY SERVICE: Complete service and parts for Ampex equipment; professional audio, helical-scan video systems and professional audio motor and head assembly rebuilding. Ampex Service Center, 719 W. Algonquin Road, Arlington Heights, IL 60005, 1-800-323-0692 or (312) 593-6000.

MOVING?

Keep **db** coming without interruption!

Send in your new address *promptly*.

Enclose your old **db** mailing label, too.

Write to:

Eloise Beach, *Circ. Mgr.*
db Magazine
1120 Old Country Rd.
Plainview, N.Y. 11803



Have you misplaced your **db** again? Our high quality, royal blue vinyl binders keep 12 copies of **db** neat and handy for ready reference.

Just \$9.95, available in North America only. (Payable in U.S. currency drawn on U.S. banks.) ORDER YOURS NOW!!

Sagamore Publishing Co., Inc.
1120 Old Country Road
Plainview, NY 11803

YES! Please send **db** binders @ \$9.95 each, plus applicable sales tax
Total amount enclosed \$

Name

Company

Address

City

State Zip

People..Places..

• **Robert D. MacCormack** has been elected president and chief executive officer of **BTX Corporation**. He succeeds **David Krumholtz**, a founder and director, who becomes manager of Product Development. The announcement was made by **Glen N. Herb**, Chairman of BTX. Bob MacCormack has been an executive in the high technology field for over thirteen years and joins BTX from **Applicon, Inc.**, Burlington, Mass., where he was vice president of International Operations. He also served as general manager, **Applicon Europe, Inc.** Prior to joining Applicon, MacCormack served as assistant to the president of **Entrex, Inc.** and also was director of Software Development at **Inforex, Inc.**

• **Shure Brothers Inc.**, Evanston, Illinois, has announced the promotion of **Norman C. Guenther** to the position of manager, Quality Assurance Engineering. His responsibilities include new product evaluations and the quality auditing of Shure's plants. Guenther's previous position was Quality Control manager for Shure's Evanston plant. He joined Shure in 1974.

• **Clyde Electronics**, the Glasgow based off-shoot company of **Radio Clyde**, is extending its marketing operations to the USA. The company, following a successful **NAB** Exhibition in Dallas earlier this year, appointed two USA agents, **Marcom**, PO Box 66507, Scotts Valley, California and **Audio Techniques**, 652 Glenbrook Road, Stamford, Connecticut. In view of the interest shown in the company's products, **John Lumsden**, managing director of Clyde Electronics is moving to the USA to set up the American operation as of January 1st, 1983. John Lumsden retains his Board appointment as marketing director (USA) and **Philip Collins** takes over the running of the UK operation as managing director. Both appointments take effect from December 1st, 1982.

• **Craig Recording Studios**, Jenkintown, PA, announces two new on-site sound reinforcement accounts. They are: The current **Philadelphia Pops** program series at the Academy of Music, and the Grand Opening and special programs for the new Willow Grove Park (Mall). Producer **Moe Septee** arranged the Philadelphia Pops assignment. Besides operating a full-service recording studio, Craig, over the past year, has expanded its on-site sound reinforcement segment of the business.

• **Hans D. Batschelet** has been appointed president of **Studer Revox America**, effective January 1, 1983. The announcement was made by the outgoing president, **Bruno Hochstrasser**, who has returned to the Studer factory in Switzerland to assume the position of product manager for Professional Recording Systems. Batschelet, formerly vice president of Marketing for the Studer Division, will now direct all Studer Revox operations in the United States from the company's corporate headquarters in Nashville, Tennessee. Hochstrasser's advancement to product manager for Professional Recording Systems places him in the top echelon of management at Studer's Swiss headquarters, located near Zurich. In his new post, Hochstrasser will carry overall responsibility for all Studer programs involving professional analog recorders and associated systems.

In other Studer news, **Peter Kehoe** has been chosen to fill the position of field service engineer at Studer Revox America's New York office. Kehoe previously served as a maintenance engineer at the **Hit Factory** recording studio in New York.

• The first Alexander M. Poniatoff Gold Medal for Technical Excellence was presented to **Dr. Ray Dolby** by the **Society of Motion Picture and Television Engineers (SMPTE)** at its conference in New York City on November 8th. The annual award was sponsored by **Ampex Corporation** to honor its founder, the late **Alexander M. Poniatoff** and his commitment to technical excellence. The gold medal was presented to Dr. Dolby by **Charles Anderson**, president of SMPTE, and product planner in the Ampex Audio-Video Systems Division. Dolby was cited for his contributions to the advancement of magnetic sound recording. He is noted for his preeminent work in the design and application of noise reduction systems for use in sound recording. Millions of individual pieces of equipment currently feature Dolby noise reduction systems which have significantly improved stereophonic performance in the recorders. Dolby is past president and a Fellow of the AES and a recipient of its Silver Medal Award. He is also a Fellow of SMPTE.

• **Mort Fujii**, president of **Cetec Gauss**, has announced the following senior executive appointments: **Tom Carlile** has been named president of Gauss Loudspeakers, based in Sun Valley and **Hans Freytag** has been named European sales manager of Gauss Loudspeakers, based in England. Carlile joins Cetec Gauss after five years as president of **New West Audio Marketing Inc.** Prior to his affiliation with New West, he had been National sales manager of Gauss Loudspeakers, 1974-1977. Carlile brings to Gauss more than 10 years of experience in the professional audio and loudspeaker market, having served in several executive positions, including sales and marketing roles with **JBL, Inc.** Freytag also has been in the professional audio field for more than 10 years, serving with **ATC, Ltd., PACE Co., and Eastmill Systems Ltd.**, all based in England.

• The 1982 Scotty Board of Governors has been appointed by 3M's Magnetic Audio Video Products Division; the board will select this year's Scotty Award winners. All are prominent figures in the music recording industry. They are: **John Boylan**, writer producer; **Delos "Del" Eilers**, 3M technical service manager audio; **Jimmy Johnson**, recording engineer; **Tom Jung**, engineer producer; **George Massenburg**, engineer, and **Jim McCullagh**, magazine editor. Each will serve one year. This six man board will select Scotty-award winning teams (artist, producer, engineer and studio) from among the nominees submitted during the year. The basic qualifications for each award is that the recording (album or single) achieve gold or platinum status and that it be mastered and recorded on Scotch audio recording tape. In addition to awarding the "Scotty," 3M contributes \$1,000 to the Muscular Dystrophy Association in the name of the winning team. An additional \$100 is given to MDA in the name of each studio submitting a qualified nomination.

- **Joe Wolf** has been named to the new position of executive vice president at **Reeves Teletape**, according to an announcement by RT president **Caddy Swanson**. With the company since 1973, Wolf was previously vice president/general manager, Post-Production Services. In other Reeves news, **Jim McKenney** has been named to fill the position of vice president/general manager, Post-Production Services left vacant by the promotion of Joe Wolf.

- **Dick Asher**, deputy president and chief operating officer, **CBS Records Group**, has announced the appointment of **Joseph F. Dash** as senior vice president and general manager, **CBS Masterworks**. Mr. Dash will be responsible for all worldwide A&R, marketing and admin-

istrative activities of Masterworks—CBS Records' classical music label. In addition, he will oversee the Master-sound label of audiophile records and tapes as well as the recently established "CBS Records" label consisting of classical "crossover" releases. Since Mr. Dash joined CBS Masterworks in 1980 as vice president and general manager, the label has signed such prestigious artists as **Placido Domingo**, **Jean-Pierre Rampal** and **Phillip Glass**. Under his direction, CBS established the CBS Records crossover label, the Mastersound audiophile series and the Great Performances line of mid-priced classics. Mr. Dash joined CBS Records in 1969 as director, Planning. Prior to joining CBS he was manager, Marketing Research for a division of **Celanese Corporation**.

- **Richard Sirinsky** has been appointed director of sales development for **Ampex Corporation**; the announcement was made by **Ridley Rhind**, vice president of marketing. Sirinsky, formerly marketing manager of the Ampex Audio-Video Systems Division (AVSD), will now direct the activities of the training and teleproduction center and corporate advertising department. Rhind said that Sirinsky's new responsibilities will enable him to coordinate a broad range of corporate resources to support the company's sales and marketing efforts. Prior to his assignment as AVSD marketing manager, Sirinsky was vice president and general manager of the Europe, Africa and the Middle East area for Ampex Int'l.

.. & Happenings

Bearsville Studios Announce New Control Room



- **Bearsville Studios**, Bearsville, New York, have announced the completion of a new control room for their Studio B. According to Studio Manager **Griff McRee**, the new room, acoustically designed by **George Augspurger** (who also designed **Cherokee** and **Sigma Studios**), features a top-of-the-line complement of analog recording equipment, including a **Neve 8068** recording

console with 32 inputs, **Studer A80** Multitrack and 2 track, **B67** 2 track, **UREI 813A** monitoring, and outboard **EMT 251**.

To accompany the changes in the control room, Studio B itself has been remodeled to include movable panels on the walls which offer the option of reflective or absorptive surfaces. A producers lounge has also been con-

structed adjacent to the control room. In addition, Bearsville Studios offer a different recording environment with Studio A, which, with its 65-ft. x 40-ft. floor space and 30-ft. ceiling, is one of the largest rooms on the east coast. McRee reports that **David Kershbaum** is currently working in Studio B, completing production on **Randy Van-warmer's** next I.P.

.. & More Happenings

Movielab Video Introduces Stereo Capability



Walter Raufer, Movielab Video vice president of Engineering, checks newly-installed equipment in the new post-production facility: (left to right) Grass Valley Switches, CMX editor, AudioArts mixing console and Chryon IV character generator.

• **Walter Raufer**, vice president of Engineering at **Movielab Video, Inc.**, having anticipated the onset of stereo in cable and broadcasting, designed Movielab's two editing and two color-correction suites with state-of-the-art stereo-capable equipment. Each suite provides **AudioArts** 16-channel mixing consoles with stereo paragrahic equalizers and 1/2-inch **MCI** four-track mixing.

The facility is unique because of its

audio video combinations. The edit rooms handle up to four tracks of 1/2-inch audio, which can be interfaced into video edit sessions. The film-to-tape area can playback up to four tracks of 35 mm Mag tape, or two tracks of 16 mm. For dubbing, the entire plant can switch both left and right tracks of audio, and also video. All areas have **Dolby** systems for 1/4-in., 1-in., and Quad. Digital echo, an audio time-delay device, can also be used

to create sophisticated effects.

Audio and video time compression is another feature made possible by **Eventide's** "Time Squeeze," which permits changes in a tape's running time without changing audio pitch or picture quality. Both audio and video length are adjusted from 1-inch video tape in a one-pass, single-dub process controlled by computer.

.. & More Happenings

Some Shure Things

• The **Shure SM57** Unidirectional Dynamic Microphone has long been known as a versatile and reliable mic for sound reinforcement applications. Its reputation has been further enhanced recently as several music and sound manufacturers have taken advantage of the SM57's low-frequency response and presence peak by using SM57 cartridges as integral parts of their own design.

One such company is **Legend Amplifiers**, an East Syracuse, New York-based manufacturer that now offers an optional, built-in microphone system for their musical instrument amps. This enables the user to connect the speaker output of the amplifier directly into his sound system's mixing board. Legend amps with the "factory-miked" option feature an SM57 cartridge hard-wired to the back of the amp's cabinet. There, the user finds an XLR connector and an on/off



A Shure SM57 cartridge fitted into a May EA drum from Slingerland.

switch, permitting direct connection with the mixing board and quick engagement or disengagement of the microphone.

Another manufacturer that has taken advantage of the SM57 is **RMI** (Huntington Beach, CA), a company headed up by **Randy May**. May is a well-known studio drummer who doubles as a designer and inventor. In past years he has come up

with several unique percussion concepts, including **Pearl Drum's** Vari-Pitch feature.

May EA (Electro-Acoustical) Drums, offered as an option by **Slingerland**, utilize a slightly modified SM57 cartridge mounted inside the drum. The microphone cartridge can be rotated 180 degrees through the use of an external tuning knob, allowing the user to adjust the sound to his particular needs.

Frank Zappa is using the system in his current tour to enhance the work of drummer **Chad Wackerman**.

New Survey of Recording Studio Equipment Use

• A major independent survey of recording studio equipment usage has selected **MCI/Sony** as the leading professional multi-track brand for the sixth consecutive year. The survey, published by **Billboard Magazine**, ranks MCI/Sony number one in market position among manufacturers of full professional multi-track recorders and consoles.

The ranking is part of **Billboard's** newly published "1982-83 International Recording Equipment and Studio Directory." Based on responses from more than 600 studios, the survey indicates what percentage of studios use each major brand of sound equipment and lists total market share for each brand.

In the 16-track-and-up recorder category, 40.7 percent of all studios reported using MCI/Sony equipment, and MCI/Sony's market share was 34.1 percent. In the 16-track-and-up console category, 18 percent of all studios are using MCI/Sony and MCI/Sony's market share is 14.9 percent.

In all four tabulations MCI/Sony was the leader among fully professional brands. **TEAC/Tascam**, which manufactures semi-professional studio gear, ranked higher in the 16-track-and-up console rating.

MCI/Sony—At Home and Abroad

• Multi-track recording equipment from **MCI/Sony** is going "on the road" in the Soviet Union. **Melodiya**, the Soviet state

recording company, has acquired an MCI-equipped 32-foot remote recording van. Soviet technicians are using the van for broadcast and recording of popular, classical and ethnic music.

The customized trailer won immediate approval when it was exhibited and demonstrated in Russia recently. "We came to Moscow for an exhibit and demonstration," said **Lutz H. Meyer**, MCI/Sony's vice president of marketing, "and the Soviet engineers did not even let the unit go home. They negotiated the deal on the spot."

The van is equipped with a 24-track MCI recorder and MCI multi-track console in addition to two MCI stereo mix-down recorders.

The acoustically treated van was designed and built in Great Britain by **Clyde Electronics, Ltd.** in conjunction with MCI/Sony. The interior features an overhead signal processor bay which permits installation of outboard gear without cluttering the mixing desk area. Carpeting has been treated to reduce static charges. The van includes a kitchen and room for installation of video recording and monitoring equipment.

On the home front, equipment by MCI/Sony has been selected by **Syracuse University Archives** for the **Thomas A. Edison Re-recording Laboratory**, the world's first facility exclusively devoted to the preservation and restoration of recorded sound. Six MCI recorders and an MCI automated mixing console have been installed in the new facility.

Founded in 1963, the Syracuse University Archives is the largest private repository of its kind in the U.S., housing more than 250,000 sound recordings of various types. The new addition, to be officially dedicated this fall, is designed specially for archival transcription of early cylinders and disks as well as later tape recordings. The building includes a studio, two control rooms, a record storage area, reception catalog area, an audio equipment display room, a lecture mini theatre room, a record cleaning area/workshop and general office space.

Among projects already undertaken by the facility is a major Edison cylinder restoration effort, and the transfer to tape of a rare cylinder collection of Polynesian folk music.

INDEX 1982

INDEX BY AUTHOR

- Agnello, Anthony and Clayton, Mark.** Digital Audio Processing—The Next Step. Oct., 1982, p. 46.
- Allen, Murray.** Audio Distortion on Both Sides of the Glass. Oct., 1982, p. 40.
- Ashley, J. Robert.** Audio Conversations—Church P.A. Sound Systems. Part I. Feb., 1982, p. 38.
- Ashley, J. Robert.** Audio Conversations—Church P.A. Systems. Part II. March, 1982, p. 44.
- Beard, Dale.** Techniques for Hum and Noise Reduction. Sept., 1982, p. 47.
- Berkovitz, Robert.** The FFT: Big-Time Mathematics Comes to Audio. Aug., 1982, p. 44.
- Berkovitz, Robert.** The FFT: Big-Time Mathematics Comes to Audio. Part II. Sept., 1982, p. 52.
- Borwick, John.** A Visit to Studer-Revox. Jan., 1982, p. 24.
- Borwick, John.** Sound Engineering for Theatre and Film. Dec., 1982, p. 42.
- Borwick, John.** The 71st AES Convention. June, 1982, p. 24.
- Bourne, Kenneth M.** Professional Wireless Microphones Simplify Sound System Design. Feb., 1982, p. 43.
- Branwell, Nigel.** Selective Limiting. April, 1982, p. 52.
- Branwell, Nigel.** The Calrec Soundfield Microphone. June, 1982, p. 41.
- Brosious, Hamilton.** Recording Studio Rentals—Or—You Don't Have to Own California to Enjoy It. Oct., 1982, p. 55.
- Chan, Curtis.** The Sony PCM-3324 Digital Recording System. May, 1982, p. 46.
- Chilvers, Richard.** A Postscript on British Audio. March, 1982, p. 43.
- Clegg, Almon.** Report From Japan. March, 1982, p. 41.
- Coencas, Joseph.** New York's Center For the Media Arts Adds a School of Audio Arts. Sept., 1982, p. 57.
- Eargle, John.** An Overview of Sound Reinforcement. Feb., 1982, p. 26.
- Gordon, Jack K.** Monitoring Program Levels. Part II. Jan., 1982, p. 46.
- Graham, Bill and Churchill, Randy.** ZAP—Zero Acoustic Phase Cancellation. Nov., 1982, p. 36.
- Hammar, Peter and Ososke, Don.** The Birth of the German Magnetophon Tape Recorder. March, 1982, p. 47.
- Harvey, Robert.** The Venerable 604. Aug., 1982, p. 26.
- Hay, Thomas M.** Studio Powering and Grounding Techniques. Nov., 1982, p. 26.
- Hodges, Ralph.** Noise Reduction: Where to Next? July, 1982, p. 34.
- Hodges, Ralph.** The Wonderful Sound World of Walt Disney. Dec., 1982, p. 38.
- Holmes, David.** Sigma's New Console...Or Sphere Meets Sigma. Jan., 1982, p. 34.
- Keene, Sherman.** The Soundstream Digital Music Computer: Recording, Editing and Beyond. Sept., 1982, p. 34.
- Kothen, Bill and Bauerle, Dick.** The Construction of Select Sound Studio. May, 1982, p. 40.
- Koziol, Richard.** Remote Recording Overseas: Anticipating the Unexpected. March, 1982, p. 34.
- Koziol, Richard and D'Alessio, Alfred W.** To Build the Impossible Dream: A Sound-Insulated Performance Studio Comes to the Big Apple. Sept., 1982, p. 44.
- Larson, Bruce.** Flux-Frequency Measurements: A Means for Verifying Alignment Tape Accuracy. Jan., 1982, p. 40.
- Lobb, William.** New Sound in the Round: The Greatest Show on Earth Goes Omni. Oct., 1982, p. 52.
- Lowig, Robert.** The Ribbon Microphone Revisited. June, 1982, p. 39.
- Margolis, Garry.** Broadcast Audio—A Primer for the Recording Engineer. April, 1982, p. 54.
- Matthews, William C.** Church Sound at One Hundred-Five dB-SPL. Feb., 1982, p. 32.
- Matthews, William C.** Custom Equalization: A Science and an Art. Aug., 1982, p. 36.
- Phelan, John.** MS Without Pain. June, 1982, p. 36.
- Pohlmann, Ken.** Criteria Recording Studios: The New East Wing. May, 1982, p. 32.
- Pohlmann, Ken.** The 72nd AES Convention: Technical Sessions and workshops. Nov., 1982, p. 38.
- Rettinger, Michael.** Cost-Efficient Sound Insulation. Aug., 1982, p. 35.
- Schneider, Wolf.** The Paramount Theatre's New Sound System. Aug., 1982, p. 40.
- Sherman, Howard.** A Regional Studio on the Rise. May, 1982, p. 26.
- Sherman, Howard.** Riding the New Waves. July, 1982, p. 28.
- Shifrin, Art.** Time Code and Mr. Edison. Dec., 1982, p. 26.
- Waldstein, Mark B.** Broadcast Manufacturers Survey. April, 1982, p. 39.
- Waldstein, Mark B.** Microphone Roundup. June, 1982, p. 46.
- Watson, Alan.** An Advanced Microphone Evaluation Technique in Use at Electro-Voice. June, 1982, p. 38.
- Woram, John M.** Broadcasting and Recording in Ecuador. April, 1982, p. 44.
- Woram, John M.** Sound System Design the Altec Way. Oct., 1982, p. 58.
- Woram, John M.** The NAB Convention. June, 1982, p. 42.
- Woram, John M.** The NAB Convention. Part II. July, 1982, p. 44.
- Woram, John M.** The New World of Digital Audio. July, 1982, p. 38.
- Woram, John M.** The 72nd AES Convention: The Exhibits. Nov., 1982, p. 42.

INDEX BY TITLE

- An Advanced Microphone Evaluation Technique in Use at Electro-Voice.** Alan Watson. June, 1982, p. 38.
- An Overview of Sound Reinforcement.** John Eargle. Feb., 1982, p. 26.
- Audio Conversations—Church P.A. Sound Systems, Part I.** J. Robert Ashley. Feb., 1982, p. 38.
- Audio Conversations—Church P.A. Systems, Part II.** J. Robert Ashley. March, 1982, p. 44.
- Audio Distortion on Both Sides of The Glass.** Murray Allen. Oct., 1982, p. 40.
- Birth of the German Magnetophon Tape Recorder, The.** Peter Hammar and Don Ososke. March, 1982, p. 47.
- Broadcast Audio—A Primer for the Recording Engineer.** Garry Margolis. April, 1982, p. 54.

Broadcasting and Recording in Ecuador. John M. Woram. April, 1982, p. 44.

Broadcast Manufacturers Survey. Mark B. Waldstein. April, 1982, p. 39.

Calrec Soundfield Microphone, The. Nigel Branwell. June, 1982, p. 41.

Church Sound at One Hundred-Five dB-SPL. William C. Matthews. Feb., 1982, p. 32.

Construction of Select Sound Studio, The. Bill Kothen and Dick Bauerle. May, 1982, p. 40.

Cost-Efficient Sound Insulation. Michael Rettinger. Aug., 1982, p. 35.

Criteria Recording Studios: The New East Wing. Ken Pohlmann. May, 1982, p. 32.

Digital Audio Processing—The Next Step. Anthony Agnello and Mark Clayton. Oct., 1982, p. 46.

FFT, The: Big-Time Mathematics Comes to Audio. Robert Berkovitz. Aug., 1982, p. 44.

FFT, The: Big-Time Mathematics Comes to Audio, Part II. Robert Berkovitz. Sept., 1982, p. 52.

Flux-Frequency Measurements: A Means for Verifying Alignment Tape Accuracy. Bruce Larson. Jan., 1982, p. 40.

Mic Museum, The. June, 1982, p. 28.

Microphone Roundup. Mark B. Waldstein. June, 1982, p. 46.

Monitoring Program Levels, Part II. Jack K. Gordon. Jan., 1982, p. 46.

MS Without Pain. John Phelan. June, 1982, p. 36.

NAB Convention, The. John M. Woram. June, 1982, p. 36.

NAB Convention, The—Part II. John M. Woram. July, 1982, p. 44.

New Sound in the Round: The Greatest Show on Earth Goes Omni. William Lobb. Oct., 1982, p. 52.

New York's Center for the Media Arts Adds a School of Audio Arts. Joseph Coencas. Sept., 1982, p. 57.

Noise Reduction Update. July, 1982, p. 35.

Noise Reduction: Where to Next? Ralph Hodges. July, 1982, p. 34.

Paramount Theatre's New Sound System, The. Wolf Schneider. Aug., 1982, p. 40.

Postscript on British Audio, A. Richard Chilvers. March, 1982, p. 43.

Professional Wireless Microphones Simplify Sound System Design. Kenneth M. Bourne. Feb., 1982, p. 43.

Recording Studio Rentals—Or—You Don't Have to Own Florida to

Enjoy It. Hamilton Brosious. Oct., 1982, p. 55.

Regional Studio on the Rise, A. Howard Sherman. May, 1982, p. 26.

Remote Recording Overseas: Anticipating the Unexpected. Richard Koziol. March, 1982, p. 34.

Report From Japan. Almon Clegg. March, 1982, p. 41.

Ribbon Microphone Revisited, The. Robert Lowig. June, 1982, p. 39.

Riding the New Waves. Howard Sherman. July, 1982, p. 28.

Selective Limiting. Nigel Branwell. April, 1982, p. 52.

70th AES Convention, The. Feb., 1982, p. 51.

71st AES Convention, The. John Borwick. June, 1982, p. 24.

72nd AES Convention: The Exhibits. John M. Woram. Nov., 1982, p. 42.

72nd AES Convention: Technical Sessions and Workshops. Ken Pohlmann. Nov., 1982, p. 42.

Sigma's New Console...Or Sphere Meets Sigma. David Holmes. Jan., 1982, p. 34.

Sony PCM-3324 Digital Recording System, The. Curtis Chan. May, 1982, p. 46.

Sound Engineering for Theatre and Film. John Borwick. Dec., 1982, p. 42.

Soundstream Digital Music Computer, The: Recording, Editing and Beyond. Sherman Keene. Sept., 1982, p. 34.

Sound System Design the Altec Way. John M. Woram. Oct., 1982, p. 58.

Studio Powering and Grounding Techniques. Thomas M. Hay. Nov., 1982, p. 26.

Techniques for Hum and Noise Reduction. Dale Beard. Sept., 1982, p. 47.

Time Code and Mr. Edison. Art Shifrin. Dec., 1982, p. 26.

To Build the Impossible Dream: A Sound-Insulated Performance Studio Comes to the Big Apple. Richard Koziol and Alfred W. D'Alessio. Sept., 1982, p. 44.

Wonderful Sound World of Disney, The. Ralph Hodges. Dec., 1982, p. 38.

ZAP—Zero Acoustic Phase Cancellation. Bill Graham and Randy Churchill. Nov., 1982, p. 36.

INDEX BY SUBJECT

APPLICATION NOTES

Techniques for Hum and Noise Reduction. Dale Beard. Sept., 1982, p. 47.

ZAP—Zero Acoustic Phase Cancellation. Bill Graham and Randy Churchill. Nov., 1982, p. 36.

BROADCAST AUDIO

Broadcast Audio—A Primer for the Recording Engineer. Garry Margolis. April, 1982, p. 54.

Broadcast Manufacturers Survey. Mark B. Waldstein. April, 1982, p. 39.

To Build the Impossible Dream: A Sound-Insulated Performance Studio Comes to the Big Apple. Richard Koziol and Alfred W. D'Alessio. Sept., 1982, p. 44.

CONSOLES

Sigma's New Console...Or Sphere Meets Sigma. David Holmes. Jan., 1982, p. 34.

CONVENTION REPORTS

NAB Convention, The. John M. Woram. June, 1982, p. 42.

NAB Convention Report, Part II. John M. Woram. July, 1982, p. 44.

New World of Digital Audio, The. John M. Woram. July, 1982, p. 38.

71st AES Convention, The. John Borwick. June, 1982, p. 24.

72nd AES Convention: The Exhibits. John M. Woram. Nov., 1982, p. 42.

72nd AES Convention: Technical Sessions and Workshops. Ken Pohlmann. Nov., 1982, p. 38.

DIGITAL AUDIO

Digital Audio Processing—The Next Step. Anthony Agnello and Mark Clayton. Oct., 1982, p. 46.

New World of Digital Audio, The. John M. Woram. July, 1982, p. 38.

Sony PCM-3324 Digital Recording System, The. Curtis Chan. May, 1982, p. 46.

Soundstream Digital Music Computer, The: Recording, Editing and Beyond. Sherman Keene. Sept., 1982, p. 34.

HISTORICAL

Birth of the German Magnetophon Tape Recorder, The. Peter Hammar and Don Ososke. March, 1982, p. 47.

Time Code and Mr. Edison. Art Shifrin. Dec., 1982, p. 26.

INTERNATIONAL AUDIO

Broadcasting and Recording in Ecuador. John M. Woram. April, 1982, p. 44.

Postscript on British Audio, A. Richard Chilvers. March, 1982, p. 43.

Remote Recording Overseas: Anticipating the Unexpected. Richard Koziol. March, 1982, p. 34.

Report From Japan. Almon Clegg. March, 1982, p. 41.

Visit to Studer-Revox, A. John Borwick. Jan., 1982, p. 24.

LOUDSPEAKERS

Venerable 604, The. Robert Harvey. Aug., 1982, p. 26.

MICROPHONES

- An Advanced Microphone Evaluation Technique in Use at Electro-Voice.** Alan Watson. June, 1982, p. 38.
- Calrec Soundfield Microphone System, The.** Nigel Branwell. June, 1982, p. 41.
- Microphone Roundup.** Mark B. Waldstein. June, 1982, p. 46.
- MS Without Pain.** John Phelan. June, 1982, p. 36.
- Professional Wireless Microphones Simplify Sound System Design.** Kenneth M. Bourne. Feb., 1982, p. 43.
- Ribbon Microphone Revisited, The.** Robert Lowig. June, 1982, p. 39.

MISCELLANEOUS

- Cost-Efficient Sound Insulation.** Michael Rettinger. Aug., 1982, p. 35.
- New York's Center for the Media Arts Adds a School of Audio Arts.** Sept., 1982, p. 57.
- Recording Studio Rentals—Or—You Don't Have to Own Florida to Enjoy It.** Oct., 1982, p. 55.
- Riding the New Waves.** Howard Sherman. July, 1982, p. 28.

SIGNAL PROCESSING

- Custom Equalization: A Science and an Art.** William C. Matthews. Aug., 1982, p. 36.
- Digital Audio Processing—The Next Step.** Anthony Agnello and Mark Clayton. Oct., 1982, p. 46.
- Noise Reduction—Where to Next?** Ralph Hodges. July, 1982, p. 34.
- Selective Limiting.** Nigel Branwell. April, 1982, p. 52.

SOUND REINFORCEMENT

- An Overview of Sound Reinforcement.** John Eargle. Feb., 1982, p. 26.
- Audio Conversations—Church P.A. Sound Systems, Part I.** J. Robert Ashley. Feb., 1982, p. 38.
- Audio Conversations—Church P.A. Sound Systems, Part II.** J. Robert Ashley. March, 1982, p. 44.
- Church Sound at One Hundred-Five dB-SPL.** William C. Matthews. Feb., 1982, p. 32.
- New Sound in the Round: The Greatest Show on Earth Goes Omni.** William Lobb. Oct., 1982, p. 52.
- Paramount Theatre's New Sound System, The.** Wolf Schneider. Aug., 1982, p. 40.
- Sound System Design the Altec Way.** John M. Woram. Oct., 1982, p. 58.

STUDIOS

- Audio Distortion on Both Sides of the Glass.** Murray Allen. Oct., 1982, p. 40.

- Construction of Select Sound Studio, The.** Bill Kothen and Dick Bauerle. May, 1982, p. 40.
- Criteria Recording Studios: The New East Wing.** Ken Pohlmann. May, 1982, p. 32.
- Regional Studio on the Rise, A.** Howard Sherman. May, 1982, p. 26.

TESTS AND MEASUREMENTS

- FFT: Big-Time Mathematics Comes to Audio, Part I.** Robert Berkovitz. Aug., 1982, p. 44.
- FFT: Big-Time Mathematics Comes to Audio, Part II.** Robert Berkovitz. Sept., 1982, p. 52.
- Flux-Frequency Measurements: A Means for Verifying Alignment Tape Accuracy.** Bruce Larson. Jan., 1982, p. 40.
- Monitoring Program Levels, Part II.** Jack K. Gordon. Jan., 1982, p. 46.
- Techniques for Hum and Noise Reduction.** Dale Beard. Sept., 1982, p. 47.

VIDEO AND FILM

- Sound Engineering for Theatre and Film.** John Borwick. Dec., 1982, p. 42.
- Wonderful Sound World of Walt Disney, The.** Ralph Hodges. Dec., 1982, p. 38.

INDEX BY COLUMNIST

BARRY BLESSER

- Building an Audio Processor.** May, 1982, p. 16.
- Digital Filter Design: Part I.** Sept., 1982, p. 12.
- Digital Filters: Part II.** Oct., 1982, p. 12.
- Digital Filters: Part III.** Nov., 1982, p. 8.
- Digital Filters: Part IV.** Dec., 1982, p. 20.
- Digital Filters: Corruption.** Aug., 1982, p. 10.
- Digital Filters: The Basic Types.** July, 1982, p. 18.
- Digital Signal Processing: A New Beginning.** June, 1982, p. 12.
- Flip-Flop Issues.** March, 1982, p. 18.
- Flipping and Flopping.** Feb., 1982, p. 18.
- High Level Architecture.** April, 1982, p. 10.
- It's Not Where You Are, But How You Got There.** Jan., 1982, p. 10.

NORMAN H. CROWHURST

- Engineering Problem Solving.** March, 1982, p. 24.
- Parameters & Viewpoints.** Feb., 1982, p. 14.

JOHN EARGLE

- Combining HF and LF Elements.** Sept., 1982, p. 30.

- Compression Drivers.** March 1982, p. 10.
- Dividing Networks.** Aug., 1982, p. 19.
- High-Frequency Horns and Acoustic Lenses: Part I.** April, 1982, p. 28.
- High-Frequency Horns and Acoustic Lenses: Part II.** May, 1982, p. 20.
- Low-Frequency Systems, Part I.** June, 1982, p. 16.
- Ported Low-Frequency Systems in Sound Reinforcement.** July, 1982, p. 10.
- Sound Fields, Part I.** Oct., 1982, p. 20.
- Sound Fields, Part 2.** Nov., 1982, p. 20.
- Sound Fields, Part 3.** Dec., 1982, p. 8.

- Low-Frequency Systems, Part 1.** June, 1982, p. 16.
- Ported Low-Frequency Systems in Sound Reinforcement.** July, 1982, p. 10.
- Sound Fields, Part 1.** Oct., 1982, p. 20.

LEN FELDMAN

- AM Stereo—The Beginning or the End.** June, 1982, p. 10.
- A New Approach to Post-Production Audio For Video.** Oct., 1982, p. 30.
- Another David & Goliath Scenario.** April, 1982, p. 24.
- Audio For Video—A Period of Transition.** May, 1982, p. 8.
- Digital Audio Via the Video Route.** March, 1982, p. 28.
- Fitting PCM Audio Into the NTSC VCR Format.** Jan., 1982, p. 16.
- Is Audio For Video Going Digital or FM?** Nov., 1982, p. 14.
- Pro Video Borrows Consumer Tape For New VTR Format.** Sept., 1982, p. 24.
- Tape—Another Common Denominator Between Audio and Video.** Dec., 1982, p. 25.
- The "Right to Tape" Movement.** Feb., 1982, p. 10.
- Who's Afraid of Stereo TV?** July, 1982, p. 24.

KEN POHLMANN

- Babylonian Astronomy and Digital Filters.** Sept., 1982, p. 18.
- Doppelgangers.** May, 1982, p. 12.
- Doppelgangers Again.** June, 1982, p. 20.
- Infinitesimal Calculus.** Dec., 1982, p. 14.
- Insomnia Distortion.** Nov., 1982, p. 22.
- My Lunch With Beverly.** Aug., 1982, p. 16.
- The Audioprocessor.** July, 1982, p. 14.
- The Problem of Audio Uncertainty.** April, 1982, p. 16.
- The Sal-Mar Construction.** Oct., 1982, p. 26.

Introducing
the audio processor that remembers.

Super Prime Time™

The first **Microprocessor-based** special effects device. It has non-volatile memory storage for special effects . . . recalls them on command . . . in the studio or on stage. Now, with Lexicon's Super Prime Time digital delay — the **first programmable, microprocessor-based audio processor** — you can create . . . store . . . and effects for any given piece of music, frequency response of 20 Hz to 20kHz. There's never been an audio processor like it. For the performer, Super Prime Time opens a whole new world of virtually unlimited musical enhancements. This remarkable system stores 8 factory preset programs and 32 user programs of effects . . . recallable at any time. Programs may be off-loaded to audio tapes or cassettes providing unlimited off-line storage. Super Prime Time. The first microprocessor-based delay . . . the audio processor that remembers. Write for full details today.



Lexicon, Inc. 50 Turner Street, Waltham, MA 02154/(617) 891-6790/TELEX 923468
Export: Gotham Export Corporation, New York, NY 10014

Lexicon

"Untwisting all the chains that tie the hidden soul of harmony."

Milton, 1608-1674.

Knowledge is the key to unequalled audio equalisation — and Klark-Teknik's DN60 Audio Spectrum Analyser is a rack-mounted, laboratory standard instrument that provides instantly usable information for an enormous range of applications. With continuous measurement and display of signal levels at 30 points across a broad audio spectrum from 25Hz to 20KHz, this cost-effective microprocessor-based analyser adds new standards of accuracy to the audio professional's vocabulary.

For easy equalisation, the 30 measurement frequencies of the DN60 exactly match the control frequencies of our latest two-channel DN30/30 equaliser. Add the inexpensive RT60 Reverberation Analyser to untangle structural reflections. Result: exact knowledge permits exact adjustment of response levels for total control of sound consistency. DN60 has got the features you need, because it is:

The most powerful audio-analyser on the market today — and because it is microprocessor-based, not only accurately monitoring the full audio band from 25Hz to 20KHz but also offering three memories plus a peak hold memory.

Options include X/Y plotter, dot matrix printer, the matched RT60 Reverberation Decay Analyser and a calibrated measuring microphone.

It is a tough but compact rack-mounted instrument with easy operation and superb 'lights-out' readability, and it is tested rigorously to Klark-Teknik's usual high standards, with a long burn-in period to ensure maximum reliability on the road and in the studio.

ALL THESE USES!

- Tape recorder alignment
- Room acoustical analysis
- Microphone/loudspeaker design and testing
- Reverberation checks
- Continuous system quality control
- Audio components research and development
- Fast semi-automatic production testing
- Selective noise level checks and environmental analysis
- Quality assurance for VTR audio channels
- Broadcast programme quality monitoring
- Music content analysis and level monitoring
- Level optimisation in disc cutting

For technical details ask for: Our DN60/RT60 Data Sheet. Our DN30/30 Data Sheet.



KLARK TEKNIK
sound science

Klark-Teknik Electronics Inc.
262a Eastern Parkway, Farmingdale, NY 11735, USA.
Telephone: (516) 249-3660

Omnimedia Corporation Limited
9653 Côte de Liesse/Dorval, Quebec H9P 1A3, Canada.
Telephone: (514) 636 9971

Manufactured by Klark-Teknik Research Limited, England.
Circle 45 on Reader Service Card

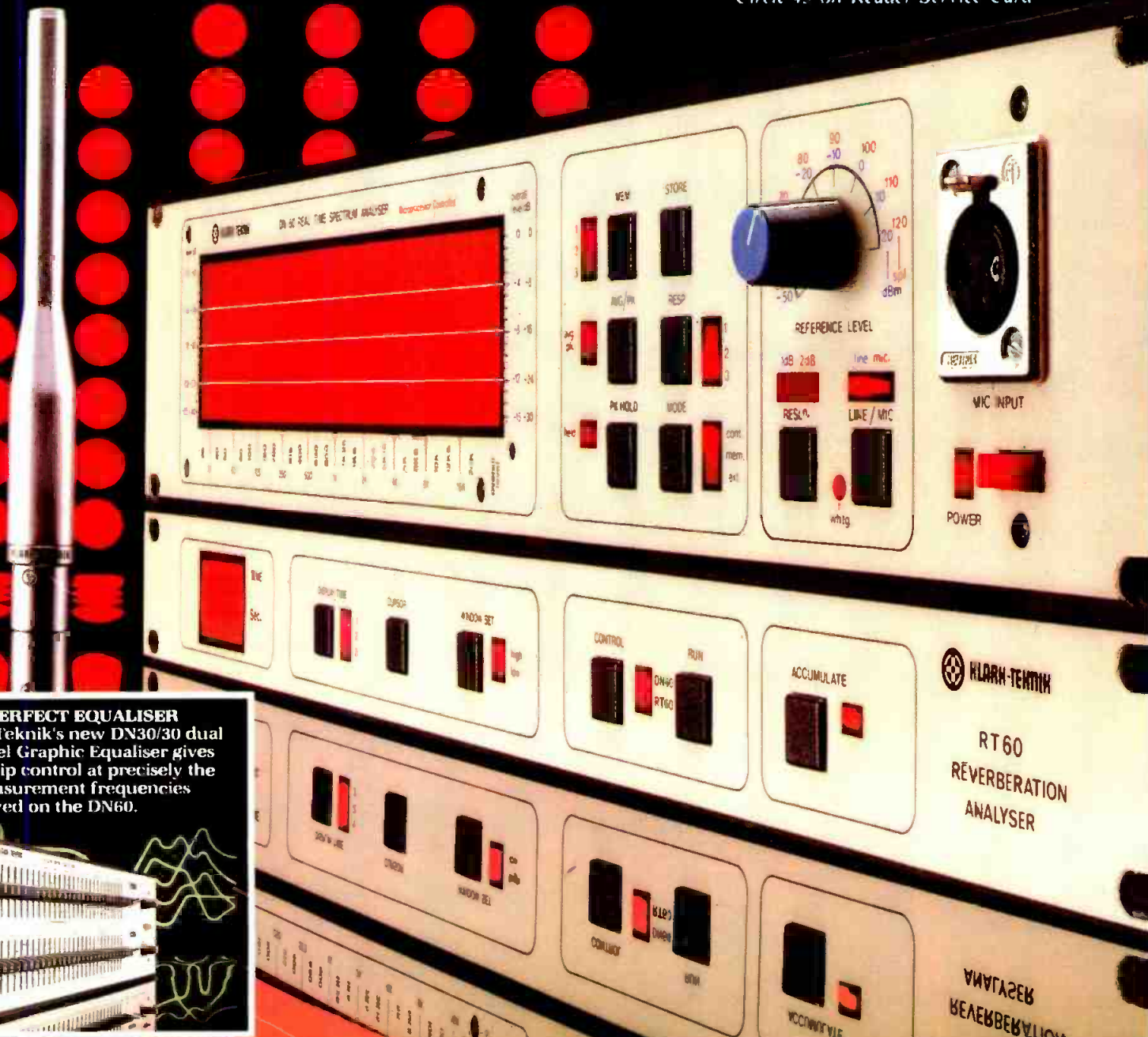

THE PERFECT EQUALISER
Klark-Teknik's new DN30/30 dual channel Graphic Equaliser gives fingertip control at precisely the 30 measurement frequencies displayed on the DN60.